

OZPCS-RS40-PS

Power Conversion System

38kW Bi-Directional DC Power Supply Rack Scale™ Series

USER MANUAL
UM-0066



11 Continental Boulevard, Merrimack, NH 03054
603. 546. 0090 Trystar.com



About Oztek

Oztek Corp. is a proven innovator of power, control, and instrumentation solutions for the most demanding industrial applications. Oztek products include variable motor drives, grid tie inverters, frequency converters, standalone inverters, DC/DC converters, and DSP based control boards for power control applications.

Trademarks

OzPCS is a trademark of Oztek Corp. Other trademarks, registered trademarks, and product names are the property of their respective owners and are used herein for identification purposes only.

Notice of Copyright

Oztek OZpcs-RS40-PS Bi-Directional Offline DC Power Supply User's Manual © June 2018 Oztek Corp. All rights reserved.

Exclusion for Documentation

UNLESS SPECIFICALLY AGREED TO IN WRITING, Oztek Corp. ("Oztek")

- (A) MAKES NO WARRANTY AS TO THE ACCURACY, SUFFICIENCY OR SUITABILITY OF ANY TECHNICAL OR OTHER INFORMATION PROVIDED IN ITS MANUALS OR OTHER DOCUMENTATION.

- (B) ASSUMES NO RESPONSIBILITY OR LIABILITY FOR LOSSES, DAMAGES, COSTS OR EXPENSES, WHETHER SPECIAL, DIRECT, INDIRECT, CONSEQUENTIAL OR INCIDENTAL, WHICH MIGHT ARISE OUT OF THE USE OF SUCH INFORMATION. THE USE OF ANY SUCH INFORMATION WILL BE ENTIRELY AT THE USER'S RISK.

- (C) IF THIS MANUAL IS IN ANY LANGUAGE OTHER THAN ENGLISH, ALTHOUGH STEPS HAVE BEEN TAKEN TO MAINTAIN THE ACCURACY OF THE TRANSLATION, THE ACCURACY CANNOT BE GUARANTEED. APPROVED OZTEK CONTENT IS CONTAINED WITH THE ENGLISH LANGUAGE VERSION WHICH IS POSTED AT WWW.OZTEKCORP.COM.

Date and Revision

April 2024 Rev U

Part Number

UM-0066

Contact Information

USA

Telephone: 603-546-0090

Email techsupport@oztekcorp.com

IMPORTANT SAFETY INSTRUCTIONS

SAVE THESE INSTRUCTIONS

This manual contains important instructions for the Ozpcs-RS40-PS power conversion system (PCS), that shall be followed during installation and maintenance of the PCS. The Ozpcs-RS40-PS is designed and tested according to international safety requirements, but as with all electrical and electronic equipment, certain precautions must be observed when installing and/or operating the PCS. To reduce the risk of personal injury and to ensure the safe installation and operation of the Ozpcs-RS40-PS, you must carefully read and follow all instructions, cautions and warnings in this installation guide.

Warnings in this Document

The following safety notices are provided for your safety and as a means of preventing damage to the product or components in the application. Specific Dangers, Warnings, and Cautions are listed at the beginning of the relevant sections and are repeated or supplemented at critical points throughout these sections. Please read the information carefully since it is provided for your personal safety and will also help prolong the service life of your PCS and the equipment you connect to it.



DANGER

This symbol indicates high voltage. It calls your attention to items or operations that could be dangerous to you and other persons operating this equipment. Read the message and follow the instructions carefully.



WARNING

Indicates a potentially hazardous situation which, if not avoided, can result in serious injury or death.



CAUTION

Indicates a potentially hazardous situation which, if not avoided, can result in minor to moderate injury, or serious damage to the product. The situation described in the CAUTION may, if not avoided, lead to serious results. Important safety measures are described in CAUTION (as well as WARNING).

Table of Contents

1. Introduction	3
1.1 Referenced Documents	3
1.2 General Information	3
1.3 General Safety	4
1.1 Orderable Part Numbers	5
2. Specifications.....	6
2.1 Reliability	6
2.2 Electrical Specifications	6
2.3 Environmental Specifications (Indoor use)	7
2.4 Mechanical Specifications	7
2.5 Accuracies.....	8
2.6 Mechanical Dimensions.....	8
2.7 Temperature Based Power Derating	10
2.8 DC Output Voltage Based Power Derating.....	11
2.9 AC Voltage Based Power Derating.....	11
2.10 Elevation Based Power Derating	12
2.11 Maintenance.....	13
2.12 Regulatory Specifications	13
2.12.1 Listings (See Appendix A)	13
2.12.2 Compliance.....	13
3. Unpacking and Inspection	14
4. Installation	15
4.1 Mechanical	15
4.2 Electrical	16
4.2.1 DC Connection.....	17
4.2.2 AC Connection.....	18
4.2.3 Low Voltage I/O.....	20
4.2.4 Configuration.....	20
5. Interface.....	21
5.1 Visual Indicators	21
5.2 Low Voltage I/O	21
5.2.1 Modbus RS-485	22
5.2.2 Inputs.....	23
5.2.2.1 Emergency Stop.....	23
5.2.2.2 Bias On/Off	23
5.2.2.3 DIN	24
5.2.3 Outputs.....	24
6. Operation	25
6.1 Bias Power	25
6.2 Output Capacitance.....	25
6.3 Basic Operation	25
6.4 Control Modes.....	26
6.4.1 DC Voltage Mode	26
6.4.2 DC Current Mode	26
6.4.3 DC Power Mode	27
6.5 Paralleling Multiple Supplies	27
6.6 Offline Auto-Resume Mode.....	28
6.6.1 Auto-Resume Disable	28
6.6.2 Auto-Resume Enable.....	28
6.7 Operating States.....	29

6.7.1	Initialize	30
6.7.2	Calibrate	30
6.7.3	Disabled.....	31
6.7.4	Charge Wait.....	31
6.7.5	Charging	31
6.7.6	Standby.....	31
6.7.7	Online	31
6.7.8	Offline.....	31
6.7.9	Fault.....	32
6.7.10	Shutdown	32
7.	Fault and Warning Conditions	32
7.1	Warnings.....	32
7.1.1	High Inverter Current – Phase A, B, C	32
7.1.2	High DC Output Current	33
7.1.3	High Grid Voltage	33
7.1.4	High Output Voltage.....	33
7.1.5	DC Current Limit.....	33
7.1.6	DC Power Limit	33
7.1.7	PLL Not Locked	33
7.1.8	High DC/DC Temperature.....	33
7.1.9	High Inverter Temperature	34
7.1.10	High Ambient Temperature	34
7.1.11	Fan Not Spinning 1,2,3	34
7.1.12	Grid Frequency OOT.....	34
7.1.13	Grid Voltage AB, BC, CA OOT	34
7.1.14	Grid Retry Delay	34
7.1.15	TVS Error.....	34
7.2	Faults	34
7.2.1	H/W and S/W Inverter Over-Current A, B, C.....	35
7.2.2	DC Output Over-Current	35
7.2.3	Grid Over-Voltage AB, BC, CA.....	35
7.2.4	H/W and S/W DC Output Over-Voltage	35
7.2.5	PLL Lost Lock.....	35
7.2.6	Over Temperature.....	35
7.2.7	Emergency Stop	36
7.2.8	Communications Heartbeat Fault	36
7.2.9	Power Down Error.....	36
7.2.10	Invalid User Configuration.....	36
7.2.11	Invalid Model.....	36
7.2.12	Offline Max Retry	36
7.2.13	Offline Timeout	36
7.2.14	Factory Fault.....	36
8.	Real Time Clock (RTC).....	38
8.1	Real Time Clock – Date Format	38
8.2	Real Time Clock – Time Format	38
8.3	Setting the Date and Time	38
8.4	Reading the Date and Time	38
9.	Data Logging	39
9.1	Event Data Logging	39

9.1.1	Fault Events	40
9.1.2	User Events.....	42
9.1.2.1	Selecting Parameters.....	42
9.1.2.2	Setting the Sample Period and Post Trigger Size.....	42
9.1.2.3	Configuring the Trigger Mode	43
9.1.2.4	Configuring Triggers	43
9.1.2.5	Reading the Log	44
9.2	Fault History Log.....	46
9.2.1	Fault Count Log	46
9.2.2	Fault Time Stamp Log.....	47
9.3	Operating History Logs	48
9.3.1	Operating Time Log	48
9.3.2	Min/Max Log	52
10.	Communications Interface	54
10.1	Modbus Overview	54
10.2	Physical Layer	56
10.3	RTU Transmission Mode.....	56
10.3.1	Synchronization.....	56
10.3.2	Slave Address	57
10.3.3	Function Code	57
10.3.4	Data Field	57
10.3.5	CRC Error Check.....	57
10.3.6	Exception Response	58
10.4	Function Code Descriptions.....	58
10.4.1	Read Holding Registers (Function Code 03).....	59
10.4.2	Preset Single Command Register (Function Code 06).....	60
10.4.3	Write Multiple Registers (Function Code 16).....	60
11.	MESA-PCS Modbus Profile	62
11.1	Register Properties	62
11.1.1	Register Number	62
11.1.2	Access Level.....	63
11.1.3	SunSpec Data Formats	63
11.1.4	SunSpec Data Type U16	63
11.1.5	SunSpec Data Type S16.....	64
11.1.6	SunSpec Data Type U32	64
11.1.7	SunSpec Data Type S32	64
11.1.8	SunSpec Data Type U64	65
11.1.9	SunSpec Data Type String.....	65
11.2	Register Models.....	65
11.2.1	SunSpec Model 1 Registers – Common Model.....	66
11.2.2	SunSpec Model 17 Registers – Serial Interface.....	67
11.2.3	SunSpec Model 103 Registers – Three Phase Inverter (Fixed Point)	67
11.2.4	SunSpec Model 64800 Registers – MESA PCS Extension	70
11.2.5	Oztek Extension Model 64050 Registers – Control and Status.....	71
11.2.6	Oztek Extension Model 64052 Registers – Alarms.....	73
11.2.7	Oztek Extension Model 64053 Registers – Grid Monitor Settings.....	75
11.2.8	Oztek Extension Model 64054 Registers – Firmware Update.....	75
11.2.9	Oztek Extension Model 64055 Registers – Datalogging.....	76
11.2.10	SunSpec Model 0xFFFF Registers – End Model.....	81

12. Servicing the Unit.....	82
13. Maintenance and Upgrade.....	82
13.1 Firmware Updates.....	82
14. Oztek Power Studio™ Tool.....	83
15. Appendix A – Records of Certification.....	85
Warranty and Product Information.....	87
Return Material Authorization Policy.....	89
Optional Extended Warranty.....	90

Table of Figures

Figure 1 - Part Number Guide	5
Figure 2 - Mechanical Outline, Front View	8
Figure 3 - Mechanical Outline - Side View	8
Figure 4 - Mechanical Outline - Rear View.....	9
Figure 5 - Mechanical Outline - Top View	9
Figure 6 - Temperature Derating Curve – “F” Option.....	10
Figure 7 - DC Output Voltage Power Derating Curve.....	11
Figure 8 - AC Line Voltage Power Derating Curve.....	12
Figure 9 - Elevation Derating Curves.....	12
Figure 10 - Shipping Contents	14
Figure 11 - Interface Identification and Location.....	16
Figure 12 - DC Terminal Block Connections	18
Figure 13 - AC Terminal Block Connections	19
Figure 14 - Low Voltage I/O Connections	20
Figure 15 - Visual Indicators.....	21
Figure 16 - Modbus Serial Interface Wiring	23
Figure 17 - Discrete Input Interface	23
Figure 18 - Discrete Output Interface	24
Figure 19 - System Block Diagram.....	25
Figure 20 - Offline Automatic Retry Fault Behavior	29
Figure 21 - State Machine	30
Figure 22 - RTU Message Frame (PDU) Format	56
Figure 23 - Oztek Power Studio™ GUI	84

Table of Tables

Table 1 - Revision History.....	1
Table 2 - Document Acronyms.....	3
Table 3 - Compatible Compression Lugs (DC).....	17
Table 4 - Compatible Compression Lugs (AC).....	19
Table 5 - LED Functions - Normal Operation	21
Table 6 - LED Functions - Bootloader Operation	21
Table 7 - I/O D-Sub 15 Pinout	22
Table 8 - Alarm Output Mask Registers	24
Table 9 - Data Logging Parameters	39
Table 10 - Fault Log Header Data Description	41
Table 11 - Fault Log Buffer Organization	41
Table 12 - User Log Variable Selection Bit Assignment	42
Table 13 - User Log Trigger Configuration Example.....	44
Table 14 - User Log Header Data Description	45
Table 15 - User Log Buffer Organization	46
Table 16 - Fault Count Buffer Organization	46
Table 17 - Fault History Buffer Arrangement.....	48
Table 18 - Operating Time Parameter Log.....	49
Table 19 - Min/Max Parameter Log.....	52
Table 20 - Modbus Interface Specifications.....	54
Table 21 - Modbus Exception Codes.....	58
Table 22 - SunSpec/MESA Models	62

Table 1 - Revision History

Rev	Date	Description of Change	Author
A	6/4/2018	Initial Release	Zendzian
B	6/8/2018	Adjusted Grid High Voltage Trip/Recover Thresholds (Section 11.2.7) to reflect recommended operating limit	Hodgdon
C	8/17/2018	Added new DC Current and DC Power control modes (Section 6.4). Added details on paralleling multiple units (Section 6.5). Major updates to register map to add new registers and remove old unused registers – references to register #'s throughout document have been updated accordingly.	Hodgdon
D	12/5/2019	Updates following certification.	Zendzian
E	1/13/2021	Updated electrical specifications for Discrete Inputs in section 2.2 to account for operating at min/max temperature. Increased operating temperature and updated temperature derating section 2.7 to clarify derating for maximum life versus maximum capability. Updated communications overview (section 10) to describe Modbus Broadcast support and to use actual PCS registers in Modbus register read/write examples. Provided descriptions for various factory fault bits (section 7.2.14) and factory data log variables (section 9). Standard warranty changed to 5 years with option to purchase extended warranty. Added section 6.2 to indicate that external capacitance is required on the DC output and added recommended range of values to section 2.2.	Hodgdon
F	2/3/2021	Updated section 9.3.1 to add more data to the Operating Time Log (time above/below 25 A _{RMS} in different temperature ranges). Fault Log sample period changed from 10ms to 1ms.	Hodgdon
G	3/26/2021	Repeated caution about cyclical writes to non-volatile memory at the beginning of the document in the General Safety section	Moisan
H	5/7/2021	Added Extended Warranty Section.	Moisan
J	6/23/2021	Fixed register references to nominal grid voltage and frequency in Section 4.2.4	Hodgdon
K	9/20/2021	Update ATM	Ciccarelli
L	5/27/2022	Updated operating temperature zone descriptions and charts in derating sections 2.7 and 2.10. Update the firmware update caution block to include a recommended delay before removing bias power. Fixed DIN_A/DIN_C descriptions in Table 7. Fixed data type for DC Current (40112) in Section 11.2.3.	Hodgdon
M	7/6/2022	Updated figures 2, 5, 10, 11, & 15 to remove circuit breaker.	Zendzian
N	12/20/2022	Updated ATM	Zendzian
P	2/1/2023	Updated High Voltage warnings in 4.2.1 Added High Voltage warning in 4.2.2 Added AC branch protection recommendations Added note regarding max screw penetration in section 3	Liberty

Q	8/9/2023	Corrected Modbus message CRC byte order in Section 10.4 tables	Hodgdon
R	10/24/2023	Changed company name to Trystar and updated ATM.	Zendzian
S	2/15/2024	Added voltage ratings for RS485 signals	Hodgdon
T	4/15/2024	Fixed BIAS_EN voltage range in Figure 17	Hodgdon
U	4/17/2024	Changed RS485 signal names from A/B to +/- for clarity. Added power on wait step to Section 6.3 Basic Operation.	Hodgdon

1. Introduction

This document is intended to provide detailed specifications and instructions on how to properly install and operate an Oztek OZpcs-RS40-PS Bi-Directional Offline DC Power Supply. To provide for safe installation and operation of the equipment, please read the safety guidelines at the beginning of this manual and follow the procedures outlined before connecting power to the power supply.

1.1 Referenced Documents

Author	Document
Oztek	Oztek Power Studio™ User's Manual (UM-0052)
Oztek	TMS28x CAN Bootloader (FS-0057)
Modbus.org	Modbus Over Serial Line v1.02
Modbus.org	Modbus Application Protocol Specification v1.1b

1.2 General Information

Throughout this document, acronyms may be employed for brevity and readability. These are summarized in Table 2.

Table 2 - Document Acronyms

Acronym	Full Text Equivalent
AC	Alternating Current
AFE	Active Front End
AWG	American Wire Gauge
CEC	California Energy Commission
DC	Direct Current
ESD	Electro Static Discharge
GUI	Graphical User Interface
HV	High Voltage
HVRT	High Voltage Ride Through
HFRT	High Frequency Ride Through
I/O	Input/Output
LVRT	Low Voltage Ride Through
LFRT	Low Frequency Ride Through
NOP	No Operation
OOT	Out of Tolerance
PCS	Power Conversion System
RH	Relative Humidity
RMS	Root Mean Square

Acronym	Full Text Equivalent
RTC	Real Time Clock
RTU	Remote Terminal Unit
STS	Static Transfer Switch
THD	Total Harmonic Distortion

1.3 General Safety



DANGER

Offline Power Supplies are typically connected to hazardous voltages. When servicing a supply, there may be exposed terminals at or above line potential, as well as residual charge in place for some time after the removal of the input source. Extreme care should be taken to protect against shock.

- 1. Before startup, observe the warnings and safety instructions provided throughout this manual. All power terminals should be considered at utility AC or high DC potential unless verified to be otherwise. These voltages are extremely dangerous and may cause death or severe injury if contacted.*
 - 2. All power terminals should be considered live with the application of input voltage regardless of operating mode of the load.*
 - 3. Do not make any connections when the power supply is connected to its power source.*
 - 4. Never work on the supply, power cables, or load when input power is applied.*
-



WARNING

- 1. Do not make any insulation or voltage withstand tests on the power supply.**
 - 2. Before servicing the unit, always ensure by measuring with a multimeter that**
 - a. There is no voltage between the AC terminals (A, B, & C) and chassis ground.**
 - b. There is no voltage between the DC terminals (+ & -), nor between either DC terminal and chassis ground.**
-

**CAUTION**

1. The power supply operates on several electrical reference points, whether these be earth ground, communication ground, signal ground, etc. Proper system design regarding equipotential bonding must be employed so that all simultaneously accessible conductive parts are electrically connected to prevent hazardous voltages appearing between them. This is accomplished by a proper factory grounding.
2. Ensure sufficient cooling for safe operation of the power supply.
3. The power supply is not field repairable. Never attempt to repair a malfunctioning unit; contact Oztek for a replacement.
4. Each power supply is sealed with a warranty void sticker across the top cover which will tear if the cover is removed. A torn warranty void sticker shall be interpreted as unauthorized access to the internal contents of the power supply, in violation of warranty terms, thereby terminating any remaining warranty otherwise in effect.

**CAUTION****Write (W) parameters must not be changed cyclically.**

The majority of registers that can be modified using Modbus Write commands (W) are non-volatile and intended for long term storage of device configuration. Cyclical changing of these parameters will lead to failure of the non-volatile memory device.

Registers used for the immediate control and limitation are an exception and may be changed cyclically with no damage to the electronics. These registers are denoted with a cyclical (C) access designator.

1.1 Orderable Part Numbers

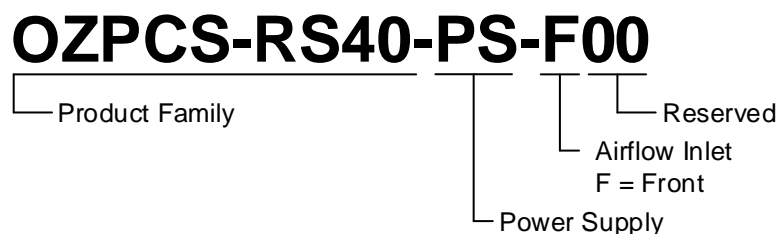

Figure 1 - Part Number Guide

2. Specifications

2.1 Reliability

Operational Life	20 Years at 25°C, 33% full load duty cycle
Service Interval	No field service required.

2.2 Electrical Specifications

General	
CEC Efficiency	96.92%
Peak Efficiency	98.22%
Standby Power	29W, Power draw from AC terminals when in Standby state
Inrush Current	<1 A, internal soft start provided
Power On Response Time	<ul style="list-style-type: none"> • 3.5 sec: time to reach Disabled state from Bias Enable input asserted • 1.1 sec: time to reach Standby state from receipt of “Start” serial command, (worst case, cold start with maximum DC input voltage) • 2 ms: time to reach Online state from receipt of “Exit Standby” serial command
AC Interface	
Number of Phases	3
Nominal Frequency	50 Hz / 60 Hz, Configurable
Operating Voltage	300 to 480 V _{rms} , Configurable
Rated AC Output Current	50 A _{RMS}
Max AC Output Over Current Protection	63 A _{RMS}
Max AC Fault Current	208 A
Max AC Fault Current Duration	2.24 msec
Power Factor	>0.99
Phase Voltage Imbalance	<10%
Output Current Distortion	<5% THD per IEEE 519 operating conditions. <3% Max at rated power
Max AC Connect Voltage	585 V _{RMS} (line to line): The supply will disconnect from the AC interface at voltages greater than this value.
DC Output	
DC Output Voltage Range	0 to 820 V
Maximum DC Output Power	38kW, Derated above 520 V, see section 2.8

Maximum DC Output Current	75 A maximum
Output Capacitance (external)	430 μ F (min), 1000 μ F (typical), 6000 μ F (max)
Discrete Outputs	
Voltage (max)	32 V _{DC}
Current (max)	5 mA
Discrete Inputs	
Voltage (min) – ESTOP, DIN	5 V _{DC}
Voltage (min) – BIAS ON/OFF	19 V _{DC}
Voltage (max)	32 V _{DC}
Current (max)	10 mA
RS-485 (“+” or “-” signal to RS485_GND)	
Voltage (min)	-7 V _{DC}
Voltage (max)	12 V _{DC}

2.3 Environmental Specifications (Indoor use)

Operating Temperature Range	-5 to 60 °C - <i>Customer derating required to meet warranty and life specifications (see section 2.7 for details)</i>
Storage Temperature Range	-20 to 60 °C
Operating Humidity Range	30 – 90% RH (no condensation)
Storage Humidity Range	10 - 95% RH (no condensation)
Operating Altitude	1,000 m No Derating, >1,000 m Derated
Pollution Degree	2 (IEC 1010-1)
Ingress Protection Rating	IPC20
Acoustic Noise	75 dBA max in all directions, horizontal distance of 3ft

2.4 Mechanical Specifications

Cooling	Forced air cooled by internal fans.
Weight	97 lb
Dimensions	19” rack, 2.5U, see section 0
Vibration	MIL-810E, method 514.4 test condition I-3.3.1 (<i>Preliminary</i>)
Shock	Less than 20G, half sine, 11mS, unpacked (<i>Preliminary</i>)
Seismic	1G seismic zone (IEEE 693 High Seismic) with seismic spectra of 0.5G (<i>Preliminary</i>)

2.5 Accuracies

Parameter	Maximum Error
AC Voltage	2%
DC Voltage	2%
AC Current	3%
DC Current	3%
Power	3%
Power Factor	5%
Frequency	0.1 Hz
Time	0.1 sec

2.6 Mechanical Dimensions

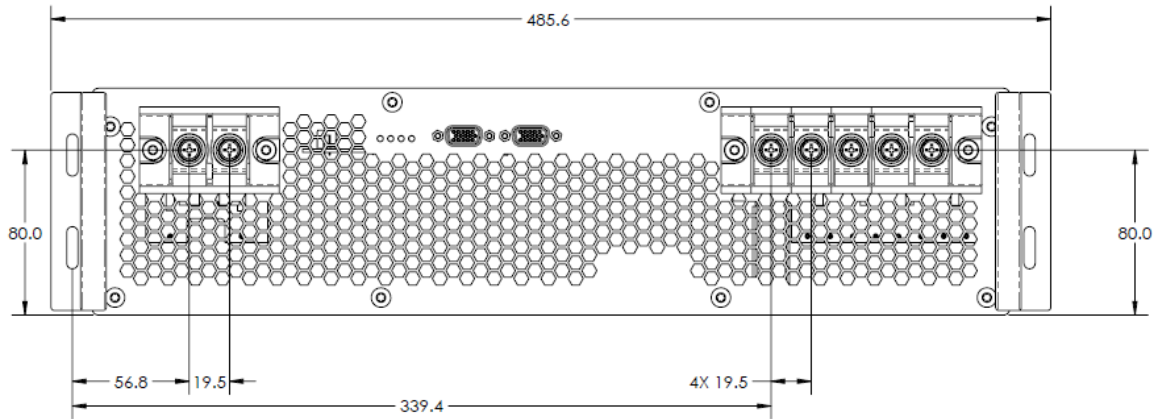

Figure 2 - Mechanical Outline, Front View

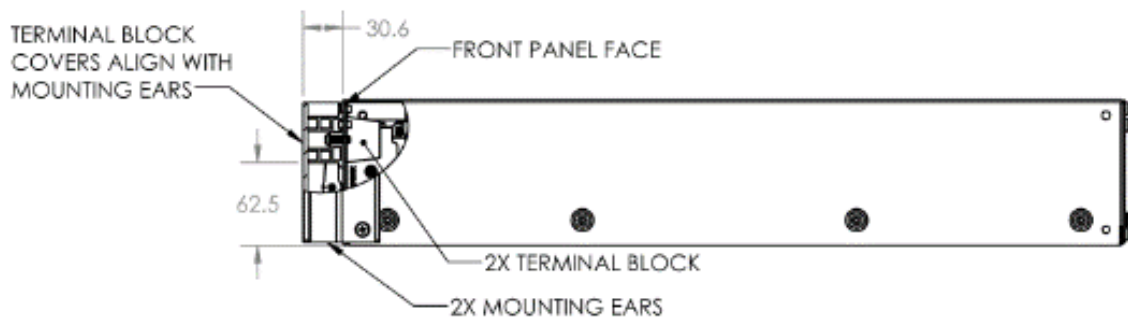

Figure 3 - Mechanical Outline - Side View

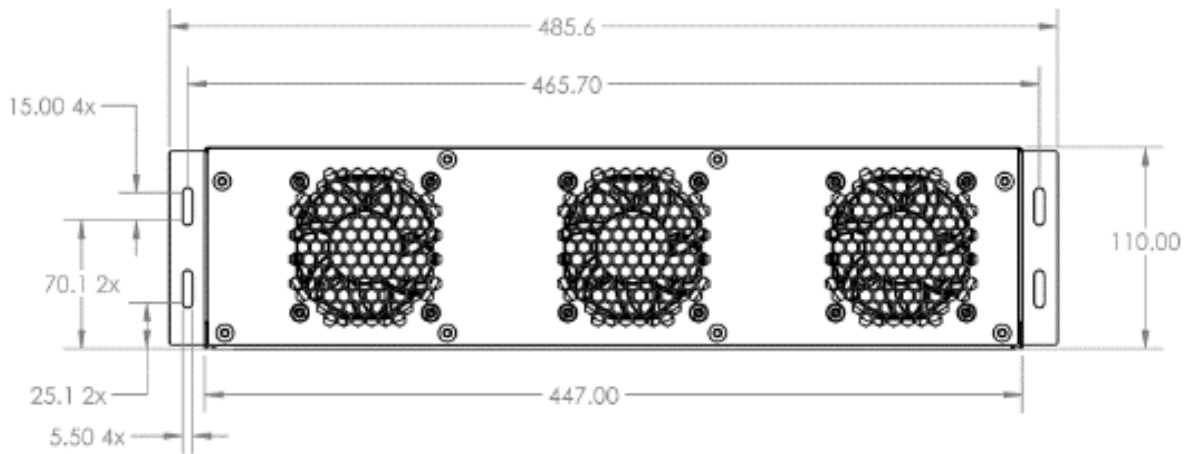

Figure 4 - Mechanical Outline - Rear View

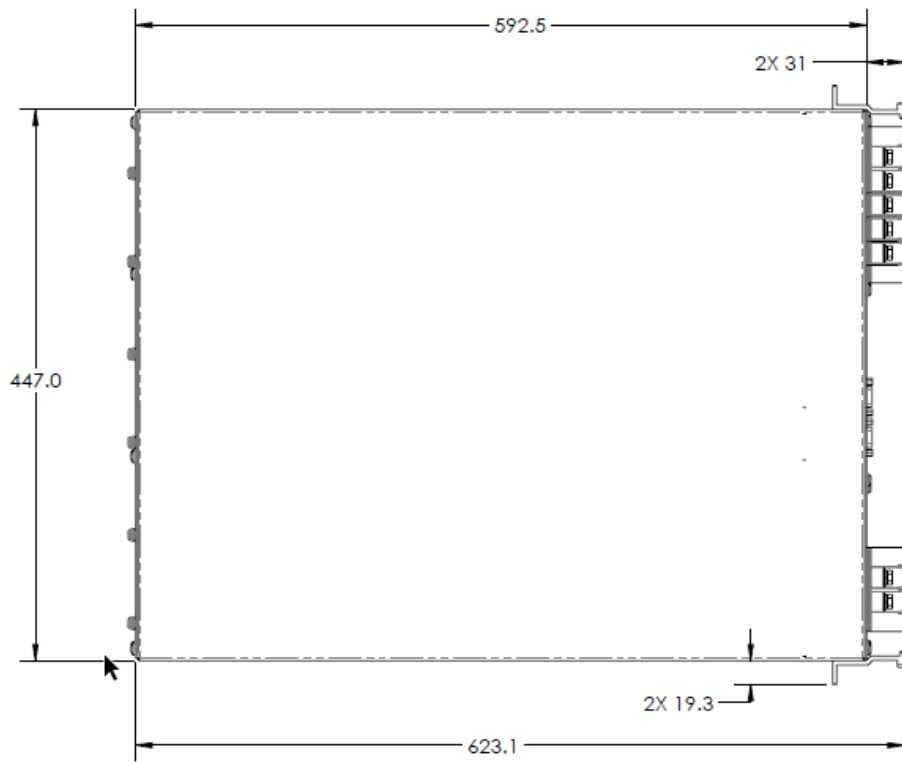

Figure 5 - Mechanical Outline - Top View

2.7 Temperature Based Power Derating

The figure below shows the continuous and peak operating temperature regions for the PCS. The green shaded region represents the continuous safe operating zone. PCS operation should be limited to this region to meet rated life and not affect the warranty period.

The yellow shaded region represents the intermittent safe operating zone. The PCS may be operated in this region for brief durations. The warranty period is not affected if the total time spent operating in this region is kept below 120 hours. Each additional hour of operation in this zone that exceeds 120 hours will reduce the warranty coverage length by one month.

The red shaded region represents the over-temperature zone. The PCS does not prohibit operation in this zone, but the unit may trip off to protect itself based on its internal over-temperature limits (internal air temperature of 70°C or power device heatsink temperature of 100°C). The end application must be configured to avoid operation in this zone. Continuous operation in this zone will void the warranty.



CAUTION

Operating the PCS for longer than 120 hours in the yellow regions shown below will shorten the product warranty as described above. Continuously operating the PCS in the red regions shown below will void the product warranty.

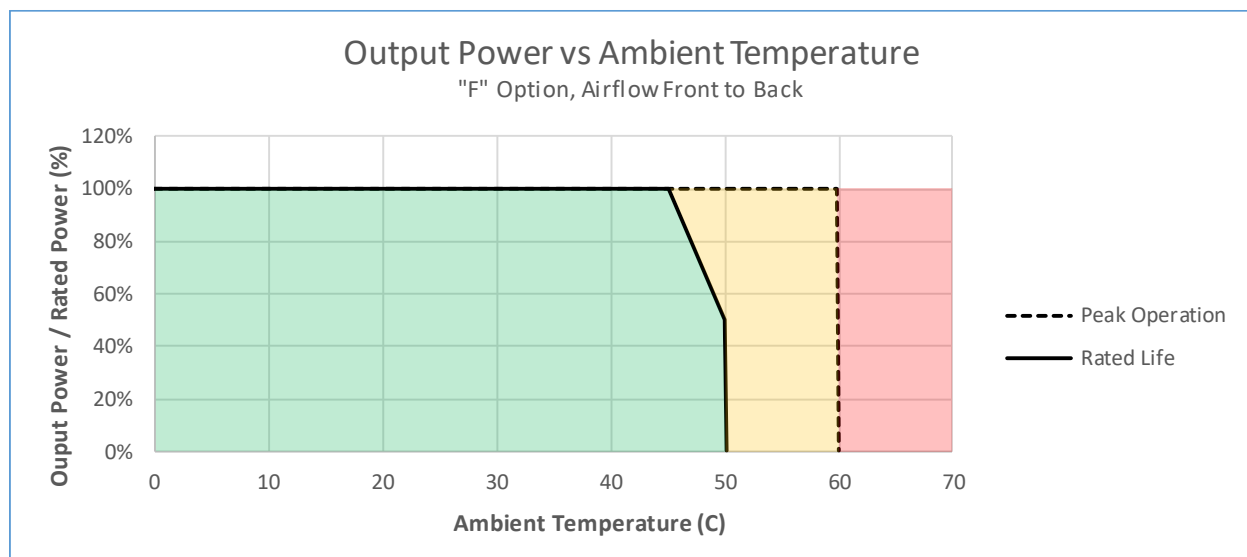

Figure 6 - Temperature Derating Curve – “F” Option

The PCS monitors the air temperature inside the enclosure using a sensor located immediately behind the front panel. Accumulated operating time across various temperature ranges is recorded as described in the Datalogging section of this document (Section 9.3). For “F” option units with front-to-back airflow, the measured air temperature is the inlet air and will match the external ambient temperature.

2.8 DC Output Voltage Based Power Derating

At lower output voltages the supply will limit the output current to its rated value. At higher output voltages, the supply limits the output power to its rated value. The resulting output power as a function of DC output voltage setpoint is plotted in the following figure.

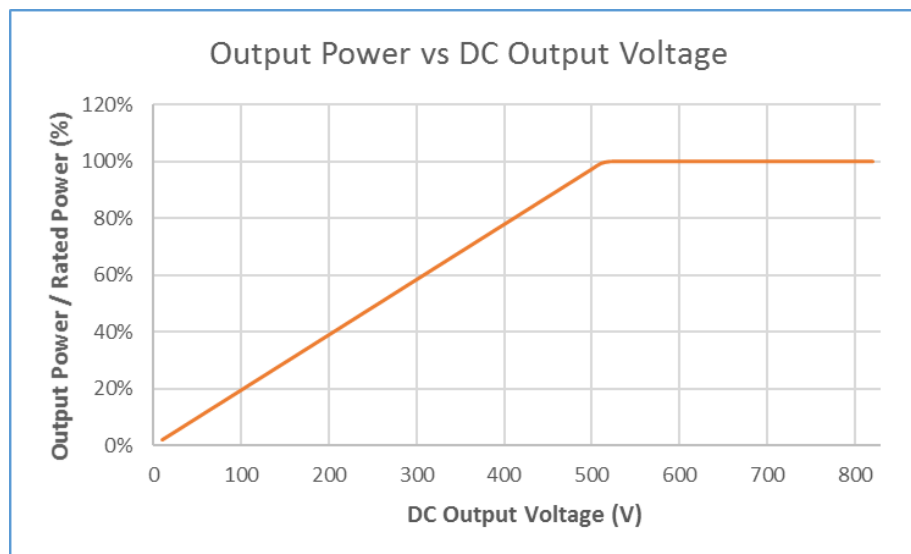

Figure 7 - DC Output Voltage Power Derating Curve

2.9 AC Voltage Based Power Derating

The supply will limit the DC output power to keep the AC current within its max rating. The resulting output power derating at various line voltages is plotted in the following figure.

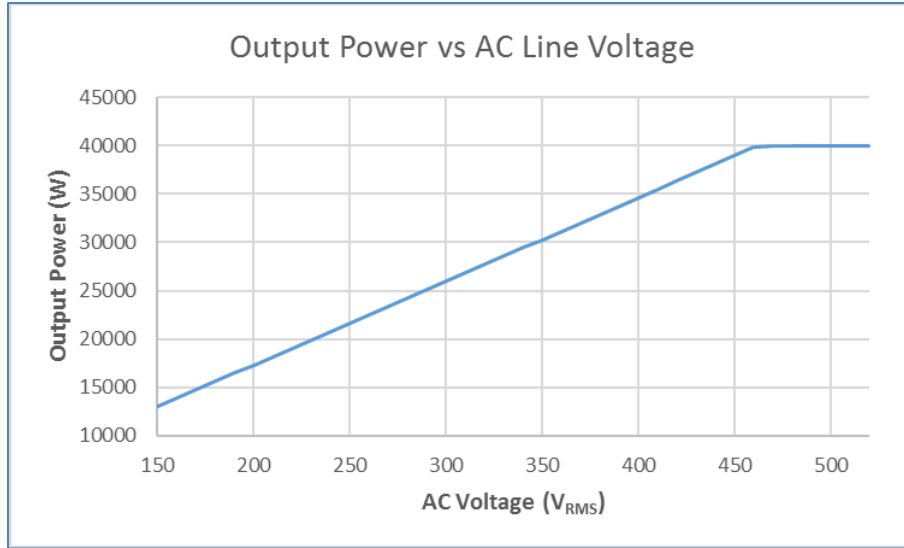

Figure 8 - AC Line Voltage Power Derating Curve

2.10 Elevation Based Power Derating

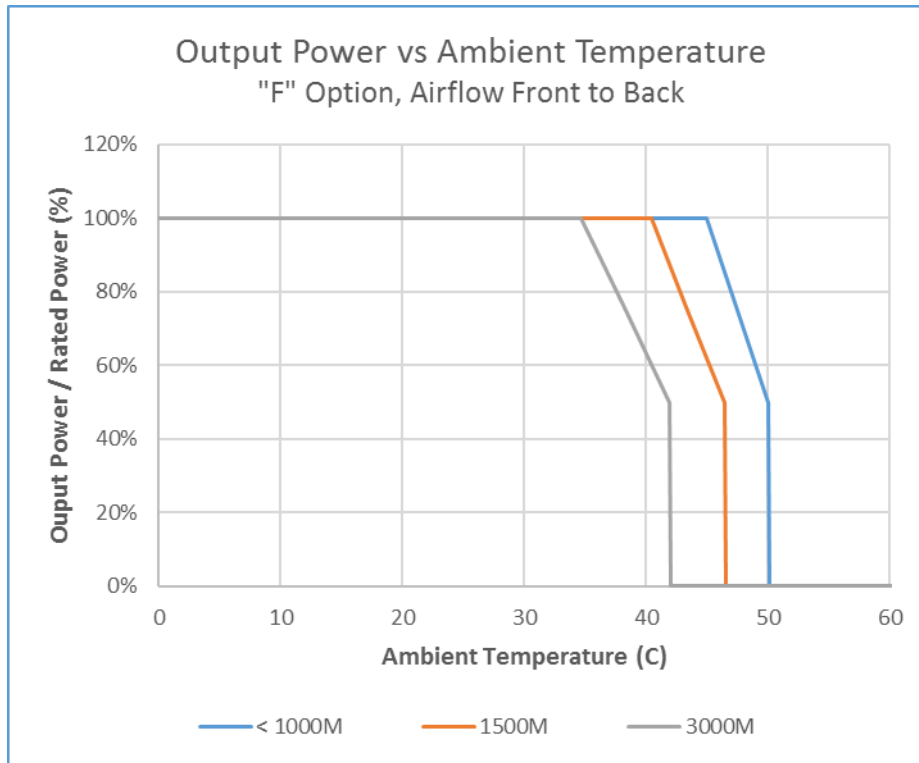

Figure 9 - Elevation Derating Curves

2.11 Maintenance

The power supply has been designed to require no maintenance over its operating life.

2.12 Regulatory Specifications

2.12.1 Listings (See Appendix A)

1.	UL1741	Inverters, Converters, Controllers and Interconnection System Equipment for Use with Distributed Energy Resources
2.	CSA C22.2	Safety Requirements for Electrical Equipment for Measurement, Control, and Laboratory Use.
3.	IEEE 1547	Standard for Interconnecting Distributed Resources with Electric Power Systems
4.	CE	Low Voltage Directive per IEC 62477-1
5.	CE	EMC Directive per EN61000-6-4 (emissions), EN61000-6-2 (immunity)
6.	SunSpec Cert # 032-001	Certified for SunSpec Information Models 1, 17, 103, 120, 121, 122, 123, 126, 129, 130, 135, 136, 139, 140, 143, 144

2.12.2 Compliance

This product is designed to comply with the following standards:

1.	IEEE 519	Recommended Practices and Requirements for Harmonic Control in Electrical Power Systems
2.	IPC9592	Performance Parameters for Power Conversion Devices (for components derating and general design guidelines)

3. Unpacking and Inspection

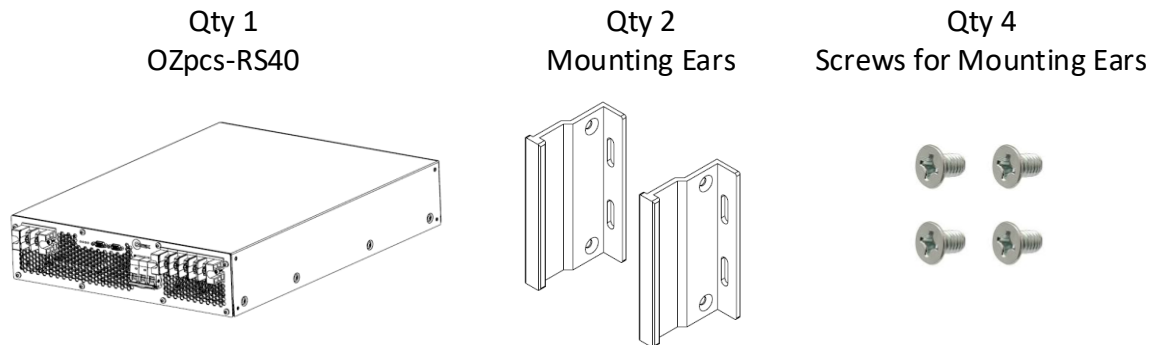

Figure 10 - Shipping Contents



CAUTION

Mechanical lift is strongly recommended. Product weight exceeds limits for individual lift. Team lift is mandatory for any manual movement of the unit before or after unpacking.

Notice: *Retain the packaging material*

Proper packaging, including internal cushioning and palletization, is required to maintain warranty coverage on any unit returning to Oztek.

1. Using the provided packing list, verify that the model received corresponds to that ordered and inspect the packaging for any signs of shipping damage. Immediately seek assistance from the freight carrier for any visible signs that the packaging or product has been damaged. If it is necessary to send the OZpcs-RS40-PS back, use the original packaging.
2. The OZpcs-RS40-PS is a sensitive electronic device. While it has been designed to mitigate risks of ESD damage under normal circumstances, care should be taken not to handle electrical interfaces unnecessarily.
3. Use the enclosed nylon handling straps to hoist the unit out of the shipping container. These straps should be retained and used for all necessary hoisting until the unit has been installed into its system mounting location.

4. Use the four provided Phillips head screws to attach the two mounting ears. Do not exceed 1.8 Nm (16 in-lb) when installing the screws. Note that the mounting ears can be installed at the front panel, where the terminal blocks are located, or at the rear panel, where the fans are situated. The unused mounting holes can be ignored, as they do not impact mechanical integrity of the enclosure.
5. User supplied bolts which penetrate the enclosure beyond 7mm will void the product warranty. Oztek strongly recommends using the supplied hardware to install rack support brackets and mounting ears.

**CAUTION**

Do not carry or lift the OZpcs-RS40-PS by the mounting ears. The mounting ears are intended as pull handles to slide the unit into or out of a rack. Attempting to lift or carry the unit with these handles may result in injury to the handler and damage to the unit.

4. Installation

4.1 Mechanical

1. Using the lifting straps in conjunction with team lift or mechanical lift best practices, raise the unit to the level at which it is to be installed into the rack.
2. Gently slide the unit onto the rack shelf/rails until the mounting ears contact the rack frame and the ear slots align with the holes in the frame.

**CAUTION**

The OZpcs-RS40-PS is not intended to be supported by the mounting ears. The unit must be installed on rails or a shelf to support its weight.

3. Using rack hardware (not provided), secure each mounting ear in two places to 3.4 Nm (30 in-lb), or to the torque value recommended by the rack provider, if specified.

4. Ensure that adequate spacing is provided from both the rear and front panels of the unit such that ventilation airflow is not obstructed. Oztek requires 40 mm (1.6") minimum clearance front and back, with greater than 50 mm (2.0") recommended.

4.2 Electrical



WARNING

All electrical installations must be done in accordance with the local and National Electrical Code®ANSI/NFPA 70 or the Canadian Electrical Code®CSA C22.1. This document does not and is not intended to replace any local, state, provincial, federal or national laws, regulation or codes applicable to the installation and use of the PCS, including without limitation applicable electrical safety codes. All installations must conform with the laws, regulations, codes and standards applicable in the jurisdiction of installation. Oztek assumes no responsibility for the compliance or noncompliance with such laws or codes in connection with the installation of the PCS.



CAUTION

Do Not Remove Panels or Cover. No user serviceable parts inside.

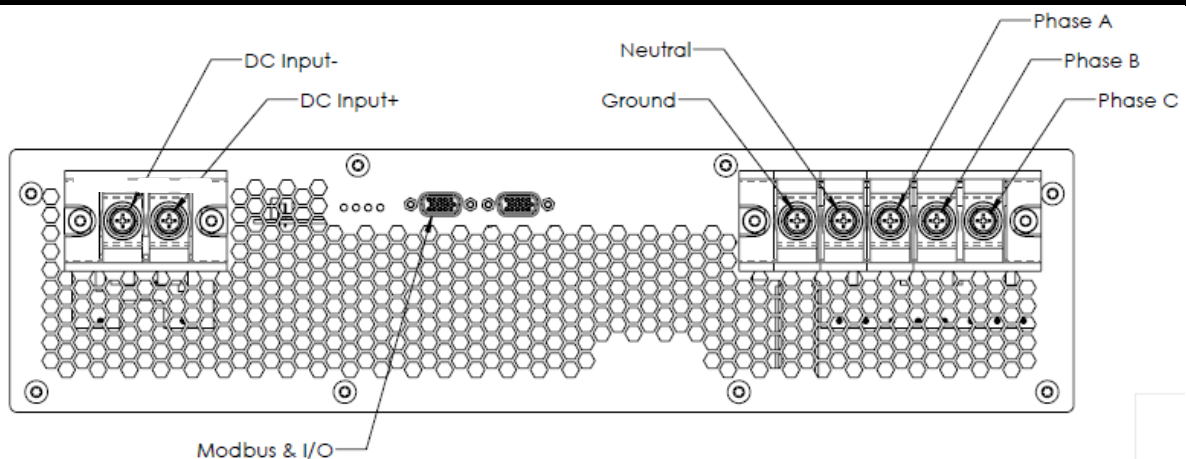

Figure 11 - Interface Identification and Location

4.2.1 DC Connection



DANGER

***High voltage may cause severe personal injury or death.
Avoid contact with electrical terminals.
De-Energize all sources before servicing.***



CAUTION

The OZpcs-RS40-PS does not include overcurrent protection on the DC terminals. The customer is required to provide adequate overcurrent protection external to the supply.



CAUTION

The DC terminals are intended to float and must not be referenced to earth ground. Referencing either DC terminal to ground will void the warranty and may cause permanent damage to the OZpcs-RS40-PS.

1. For all DC cable connections, use a minimum 4 AWG copper wire that is designed for +90 °C (+194 °F).

Notice: Ambient Temperature

The higher the ambient temperature the higher the power losses. Use cables having larger cross-sections in installations with high ambient temperatures.

2. Connections can be made using wire and compression lugs. See Table 3 for a list of compatible compression lugs.

Table 3 - Compatible Compression Lugs (DC)

Wire Size	Manufacturer	P/N
000	Panduit	LCAN3/0-14-X
00	Panduit	LCAN2/0-14-X

Wire Size	Manufacturer	P/N
0	Panduit	LCAN1/0-14-X
1	Panduit	LCAN1-14-E
2	Panduit	LCAN2-14-Q
3, 4	Panduit	LCAN4-14-L

3. Connect the negative and positive cables to the DC terminal block as shown in Figure 12. Connections should be tightened to a specified torque of 2.8 Nm (25 in-lb) +/- 5%.

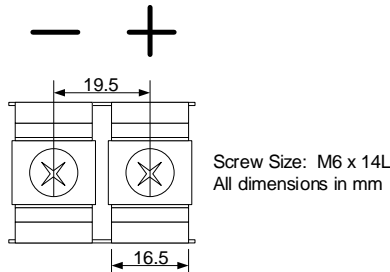

Figure 12 - DC Terminal Block Connections

4.2.2 AC Connection



DANGER

***High voltage may cause severe personal injury or death.
Avoid contact with electrical terminals.
De-Energize all sources before servicing.***



CAUTION

The OZpcs-RS40 does not include overcurrent protection on the AC input. The customer is required to provide adequate external branch level protection. The following AC branch circuit current ratings are recommended:

One unit 70A
Two units 150A
Three units 200A

1. For all AC cable connections, use a minimum 4 AWG copper wire that is designed for +90 °C (+194 °F).

Notice: Ambient Temperature

The higher the ambient temperature the higher the power losses. Use cables having larger cross-sections in installations with high ambient temperatures.

2. Connections can be made using wire and compression lugs. See Table 4 for a list of compatible compression lugs.

Table 4 - Compatible Compression Lugs (AC)

Wire Size	Manufacturer	P/N
000	Panduit	LCAN3/0-14-X
00	Panduit	LCAN2/0-14-X
0	Panduit	LCAN1/0-14-X
1	Panduit	LCAN1-14-E
2	Panduit	LCAN2-14-Q
3, 4	Panduit	LCAN4-14-L

3. Turn off the AC source and secure against turning on again.
4. Connect the ground cable as well as the three utility phase cables to the AC terminal block as shown in Figure 13. The neutral connection (N) is provisional and must be left unconnected. Connections should be tightened to a specified torque of 2.8 Nm (25 in-lb) +/- 5%.

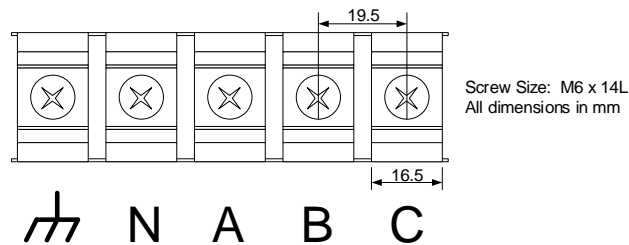

Figure 13 - AC Terminal Block Connections

4.2.3 Low Voltage I/O

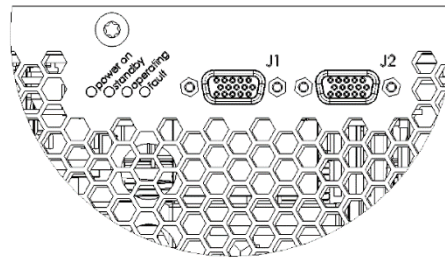

Figure 14 - Low Voltage I/O Connections

All isolated, low voltage I/O signals are provided on a standard High Density, D-Sub, 15-pin, female connector (J1). A second connector (J2) with identical pin-out is provided to allow for daisy-chaining paralleled units, as well as terminating the Modbus data link. An example of a mating connector part number is given below:

Manufacturer: Amphenol

Manufacturer p/n: 10090769-P154ALF

1. Install the primary interface cable to either connector J1 or J2. Tighten the mounting screws to no more than 0.6Nm (5 in-lb).
2. If the unit is to be daisy-chained with other units in parallel, secure a second, I/O cable to the unused connector, J1 or J2. Tighten the mounting screws to no more than 0.6Nm (5 in-lb).
3. If the unit is standalone, or the last in a string of daisy-chained units, attach a terminating jumper dongle to the unused connector, J1 or J2. Tighten the mounting screws to no more than 0.6Nm (5 in-lb). The dongle should jumper pins 4 to 5 and pins 14 to 15 to provide termination for the Modbus communications link.

4.2.4 Configuration

The OZpcs-RS40-PS is shipped from the factory configured for a nominal line voltage of 480 V_{AC} and a frequency of 60 Hz. If the OZpcs-RS40-PS is intended to be used with line voltages other than 480 V_{AC}, 60Hz, the user must configure **REG 40239 – Nominal AC Input Voltage** and **REG 40240 – Nominal AC Input Frequency** for the proper conditions.

Likewise, there are many user configurable parameters that determine the operating behavior of the power supply. It is the responsibility of the user to review this manual and the register set to ensure the supply is configured appropriately for their application.

5. Interface

5.1 Visual Indicators

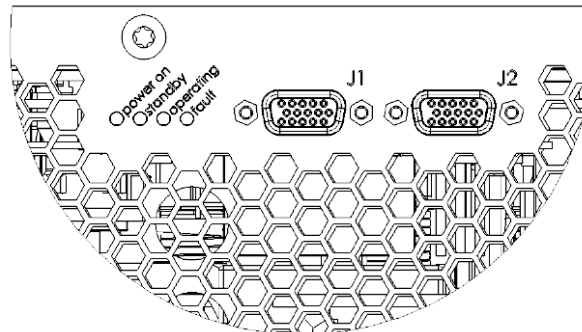

Figure 15 - Visual Indicators

The power supply includes four LED's on the front panel to indicate operating status. Table 5 defines the meaning of each LED for normal operation while Table 6 defines their meaning when the bootloader is running.

Table 5 - LED Functions - Normal Operation

Color	Label	Location	Meaning
Green	POWER ON	Front Panel	On Solid: Bias Supply is Operating
Yellow	STANDBY	Front Panel	On Solid: Supply is in Standby State
Yellow	OPERATING	Front Panel	On Solid: Supply is On
Red	FAULT	Front Panel	On Solid: System is Faulted

Table 6 - LED Functions - Bootloader Operation

Color	Label	Location	Meaning
Green	POWER ON	Front Panel	Blinking: Bootloader is running
Yellow	STANDBY	Front Panel	On Solid: Supply is connected to the Host
Yellow	OPERATING	Front Panel	Rapid Blink: Data exchange with Host in progress
Red	FAULT	Front Panel	On Solid: Bootloader error, e.g. CRC error

5.2 Low Voltage I/O

All isolated, low voltage I/O signals are provided on a standard High Density, D-Sub, 15-pin, female connector. An example of a mating connector part number is given below:

Manufacturer: Amphenol

Manufacturer p/n: 10090769-P154ALF

A second connector with identical pin-out is provided to allow for daisy-chaining paralleled units, as well as terminating the Modbus data link. The pinout for the two connectors is provided in the following table.

Table 7 - I/O D-Sub 15 Pinout

Pin #	Name	Description
1	ESTOP_C	Opto-Isolated Emergency Stop - Cathode Input
2	ESTOP_A	Opto-Isolated Emergency Stop - Anode Input
3	DOUT1_C	Opto-Isolated Output #1 – Collector
4	TERM_A	RS-485 Termination Resistor (“+” connection)
5	RS485 “+”	RS-485 “+” Data Signal
6	DIN_A	Opto-Isolated Input – Anode Input
7	BIAS_EN_A	Opto-Isolated Bias Enable – Anode Input
8	DOUT2_C	Opto-Isolated Output #2 – Collector
9	DOUT1_E	Opto-Isolated Output #1 – Emitter
10	RS485_GND	Isolated Ground for RS-485 interface
11	DIN_C	Opto-Isolated Input – Cathode Input
12	BIAS_EN_C	Opto-Isolated Bias Enable – Cathode Input
13	DOUT2_E	Opto-Isolated Output #2 – Emitter
14	TERM “-”	RS-485 Termination Resistor (“-” connection)
15	RS485 “-”	RS-485 “-” Data Signal

5.2.1 Modbus RS-485

The RS-485 interface requires three signals, “+” and “-” data signals and Ground. RS-485 is a multi-drop data bus; i.e., multiple devices can all tie directly onto the same physical signals. For proper signal integrity, the data bus must be terminated at both ends. To allow for easy wiring of paralleled units, two connectors are provided. In addition, an internal terminating resistor is provided.

Figure 16 illustrates how to correctly wire the RS-485 data bus when paralleling multiple devices. Please note the following:

- ***All three wires, “+” and “-” signal wires as well as a ground reference, should be connected.***
- ***The last device on the bus must have its terminating resistor connected by providing a jumper wire between pins 4-5 and 14-15.***



CAUTION

The RS-485 data bus must be terminated for reliable communications. Do NOT terminate every device on the bus, as this will degrade the signals and overload the transceivers. Only the devices physically located at the end of the wires should have termination.

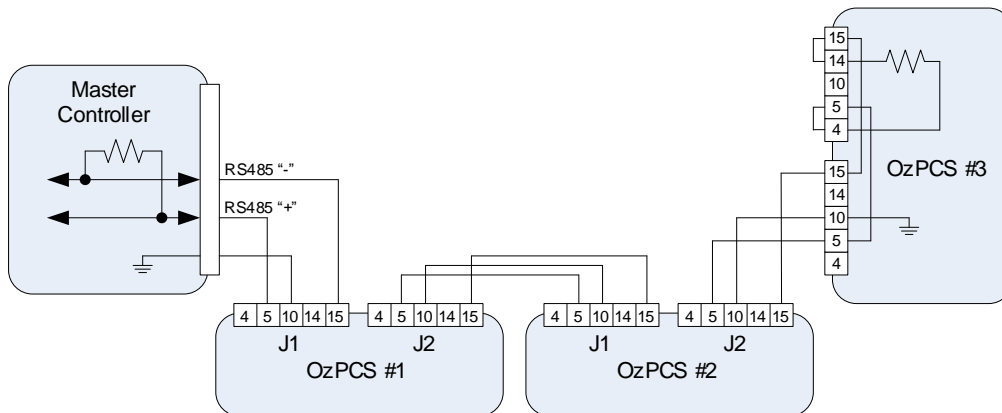

Figure 16 - Modbus Serial Interface Wiring

5.2.2 Inputs

The power supply provides three, opto-isolated, discrete inputs. The inputs are designed such that they can be directly driven with voltages up to 32V_{DC} as illustrated in Figure 17.

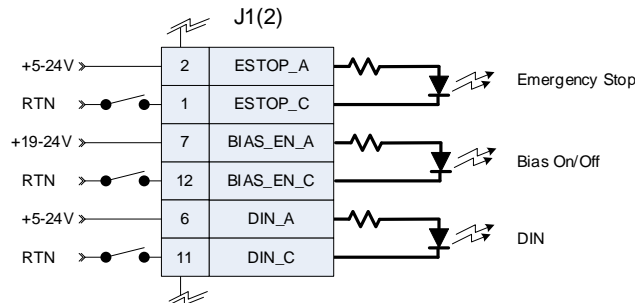

Figure 17 - Discrete Input Interface

5.2.2.1 Emergency Stop

The Emergency Stop (ESTOP) input provides a hardware-only enable path. For the supply to process power, i.e., inverter contactor closed, this input must remain asserted. The signal provides a direct hardware enable path to the AC input contactor. The power supply will report an ESTOP fault whenever this input isn't asserted.

5.2.2.2 Bias On/Off

The Bias On/Off input is used to enable the power supply's internal bias supply. As long as this opto-isolated input is asserted and a valid AC source voltage is present, the bias supply remains

operating. When this input is de-asserted, the bias supply will hold up for approximately 2.5 sec to allow the microprocessor to finish its housekeeping tasks, after which the bias supply is powered off.

5.2.2.3 DIN

The power supply has one provisional input whose function is currently undefined.

5.2.3 Outputs

There are two, opto-isolated, discrete status outputs as illustrated in Figure 18. Each of these outputs can be configured to represent a combination of selectable fault and warning events. The output polarity can be configured using **REG 40208 – Alarm Output Pin Polarity**.

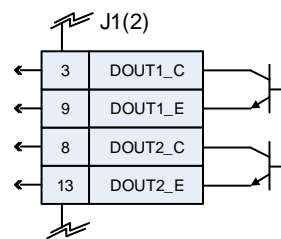

Figure 18 - Discrete Output Interface

Each output has two mask registers associated with it, one corresponding to the Fault status register, the other to the Warning status register. The table below lists the mask registers along with the corresponding status register.

Table 8 - Alarm Output Mask Registers

Alarm Output Mask Register		Status Register
40200	Alarm Output 1 – Fault Mask	40129
40202	Alarm Output 1 – Warning Mask	40131
40204	Alarm Output 2 – Fault Mask	40129
40206	Alarm Output 2 – Warning Mask	40131

Setting a bit to “1” in the mask register, will enable the corresponding fault or warning to drive that output. Setting multiple mask bits to “1” logically OR’s those fault and warnings together. For example, setting Register 40200 and 40202 to 0xFFFFFFFF, enables any fault or warning to drive Alarm Output 1. Similarly, setting Register 40204 and 40206 to 0xFFFFFFFF, enables any fault or warning to drive Alarm Output 2.

6. Operation

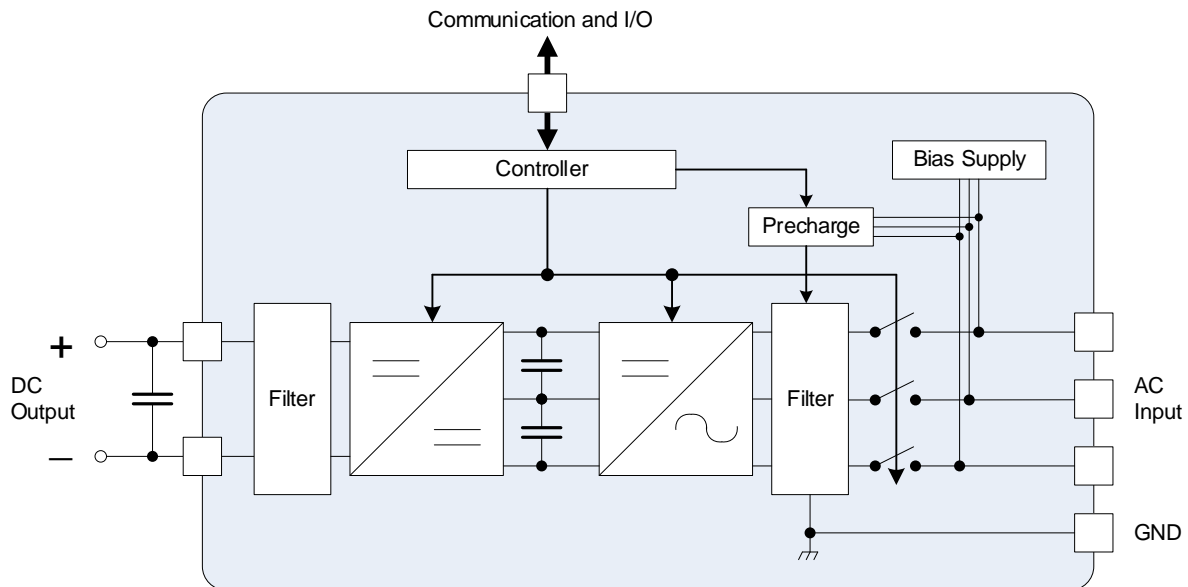

Figure 19 - System Block Diagram

6.1 Bias Power

The power supply incorporates an internal bias supply that derives the necessary working voltages from the AC input terminals. The bias supply is controlled with the “Bias On/Off” discrete input. When this input is asserted, the bias supply is enabled and drawing power from the AC terminals. When the input is de-asserted, the bias supply is disabled. Note that it may take up to 2.5 sec to turn off after the signal is de-asserted to allow orderly shutdown of the power supply controller.

6.2 Output Capacitance

As shown in Figure 19 above, external capacitance must be provided on the DC output of the OzPCS-RS40-PS for proper operation. See Section 2.2 for the recommended typical value, as well as the minimum and maximum values.

6.3 Basic Operation

Assuming all I/O and power connections to the OzPCS-RS40-PS have been made and a valid AC line is present, the OzPCS-RS40-PS can be operated as follows.

1. De-assert the Emergency Stop input by driving pins 1 and 2 of J1 or 2.
2. Enable the internal bias supply by driving the BIAS_ON/OFF input on pins 7 and 12 of J1 or J2.

3. Wait for the power on response time (approximately 3.5 seconds), after which the “**power on**” green LED will be illuminated on the front panel and the PCS is ready to respond to Modbus serial communications.
4. Clear any faults that may have been asserted by writing a 1 to **REG 40142 – Fault Reset**.
5. Perform the pre-charge operation and close the main AC line contactor by writing a 1 to **REG 40143 – Set Operation**.
6. After successfully pre-charging the internal AC filter and DC Link, the OzPCS-RS40-PS should now be in Standby, ready to be turned on. The supply can be turned on by writing a 4 (Run) to **REG 40143 – Set Operation**.
7. Once the supply is running, the output setpoint (voltage, current, or power) can be dynamically changed by writing to the associated setpoint control register (see next section for details).
8. To turn the supply off, write a 3 (Standby) to **REG 40143 – Set Operation**.

6.4 Control Modes

The power supply can be operated in one of three possible control modes: voltage control (default), current control, or power control. The desired control mode is configured using **REG 40149 – PCS Control Mode**.

6.4.1 DC Voltage Mode

When operating in DC voltage control mode, the power supply is actively regulating the DC output voltage. The default voltage setpoint following a POR is set by **REG 40154 – DC Voltage Setpoint Power-On Default**. The voltage setpoint may also be dynamically changed by writing to **REG 40151 – DC Voltage Setpoint**.

When operating in this mode, the user can configure the allowable min/max voltage setpoint as well as the voltage slew rate to use when dynamically changing the setpoint. The user may also set the maximum current and power limits to enforce when operating in this mode. See section 11.2.5 for register details.

6.4.2 DC Current Mode

When operating in DC current control mode, the power supply will actively regulate the DC output current. The default current setpoint following a POR is set by **REG 40160 – DC Current Setpoint Power-On Default**. The current setpoint may also be dynamically changed by writing to **REG 40157 – DC Current Setpoint**. Note that the polarity for all current control registers is *positive* values for current leaving the power supply and going to the load, and *negative* values for current going to the supply from the load.

When operating in this mode, the user can configure the allowable min/max current setpoint as well as the current slew rate to use when dynamically changing the setpoint. The user may also

set the maximum power limit to enforce when operating in this mode. See section 11.2.5 for register details.

6.4.3 DC Power Mode

When operating in DC power control mode, the power supply will control the DC output power by regulating the output current based on the measured DC voltage at the supply terminals. The default power setpoint following a POR is set by **REG 40165 – DC Power Setpoint Power-On Default**. The power setpoint may also be dynamically changed by writing to **REG 40162 – DC Power Setpoint**. All power control registers use the same polarity as is used for current control - *positive* values represent power flowing from the supply to the load, *negative* values for power flowing from the load back to the supply.

When operating in this mode, the user can configure the allowable min/max power setpoint as well as the power slew rate to use when dynamically changing the setpoint. The user may also set the maximum current limit to enforce when operating in this mode. Also note that when operating in power control mode, the DC current slew rate remains in effect and will override high current slew rates resulting from the configured power slew rate (more likely to occur at lower operating voltages). See section 11.2.5 for register details.

6.5 Paralleling Multiple Supplies

The OzPCS-RS40-PS power supply has been designed such that multiple units may be connected in parallel and operated simultaneously to achieve a higher total power capability in the user's end system. To communicate with and control multiple supplies at the same time, they can all be attached to a single RS-485 serial communications bus, with each unit being assigned a unique address using **REG 40069 – Modbus Device Address**. Note that each unit will have to be individually configured offline prior to attaching to the same bus as other units to ensure that each has a unique address.

When operating in DC Current or DC Power control modes, each supply can be controlled either individually by sending separate current or power commands to each unit, or concurrently by sending broadcast current or power commands to all units at the same time by writing to the standard Modbus broadcast device address of *zero*. For current or power control, it is not required that all units be operating at the same setpoint – the current from each unit will simply be summed at the load based on each unit's individual setpoint.

When operating multiple supplies in DC Voltage control mode, it is required that all units be configured identically (except for unique Modbus device addresses). Furthermore, all units should be turned ON/OFF and sent the same voltage setpoint simultaneously by writing to the Modbus broadcast device address of *zero*. To facilitate balanced load current sharing between supplies, the OzPCS-RS40-PS implements a programmable output impedance using **REG 40156 – DC Voltage Droop Control Resistance**. This register defaults to 0.25 ohms, so that for every 10A sourced by the supply, it's regulated output will be reduced by 2.5V.

**CAUTION**

Paralleled Voltage Mode supplies must be controlled simultaneously using broadcast Modbus register writes.

Each of the paralleled supplies must be assigned a unique address using **REG 40069 – Modbus Device Address**. To send broadcast commands to *ALL* supplies, when writing to the appropriate control register the user *must* use the standard Modbus broadcast device address of *zero*. Failure to send broadcast ON/OFF and voltage setpoint commands simultaneously to all supplies may result in supplies attempting to regulate at different voltages, causing them to go into current limit and circulate currents between supplies rather than to the load.

When using the Oztek Power Studio™ tool to control paralleled Voltage Mode supplies, the user *must* use the *Broadcast Commands* pane available on the *Overview* window for turning the supplies ON/OFF and changing the voltage setpoint.

6.6 Offline Auto-Resume Mode

The OzPCS-RS40-PS requires a valid AC line input to operate. If the supply is operating and the AC line voltage or frequency go beyond the high or low trip thresholds, defined by **REG 40241 – 40247**, the supply will turn off, open the AC line contactor, and transition to the **Offline** state. The supply can be configured to latch-off or auto resume from the **Offline** state.

6.6.1 Auto-Resume Disable

The auto-resume feature can be disabled by setting **REG 40250 – Offline Retry Count = 0**. When disabled, the supply will treat the condition as a fault, and latch itself off. Once the AC line recovers, the output can be reenabled using the following command sequence:

- Fault Reset command, **REG 40142 – Fault Reset = 1**
- Connect command, **REG 40143 – Set Operation = 1**
- Run command, **REG 40143 – Set Operation = 4**

6.6.2 Auto-Resume Enable

The auto-resume feature can be enabled by setting **REG 40250 – Offline Retry Count > 0**. When enabled, the supply will monitor the AC line, and upon restoration, based on the “recover” voltage and frequency thresholds, **REG 40242 – 40248**, automatically reconnect and sequence back to the **Online** state following the resume delay defined by **REG 40249**.

The supply can be configured to limit the maximum number of retries before declaring a fault using **REG 40250 – Offline Retry Count** and **REG 40251 – Offline Retry Window**. Each time a retry is attempted, a countdown timer is loaded with the value in **REG 40251** and the timer begins to count down. If the power supply goes offline, and then attempts another retry before the countdown timer expires, the retry count increments. If the retry count ever exceeds **REG 40250 – Offline Retry Count** the supply turns off and a fault is asserted. Figure 20 illustrates non-fault and fault scenarios using the default values of 2 retries and 5 seconds.

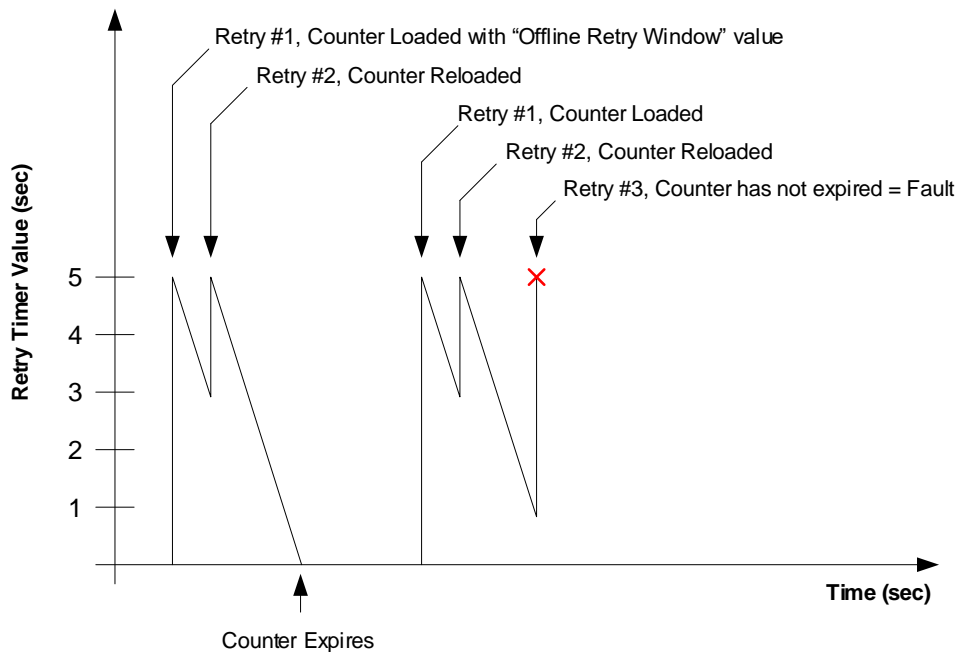

Figure 20 - Offline Automatic Retry Fault Behavior

In addition, the supply provides an Offline timeout feature. If the supply remains in the **Offline** state for longer than the time defined by **REG 40252 – Offline Timeout**, the supply will assert a fault and turn off. If the timeout value is set to zero, the timeout feature is disabled, and the supply will remain in the **Offline** state until the AC line recovers, or the user turns it off.

6.7 Operating States

A state machine is used to provide deterministic control and sequencing of the power supply hardware. Figure 21 illustrates the operating states as well as the transition logic employed in the system state machine. Each state is described in further detail below. As Figure 21 illustrates, the supply is disabled and the power stage hardware will be inoperable until the supply reaches the **Standby** state. Any attempts to turn the supply on with **REG 40143 – Set Operation** will be ignored until it reaches the **Standby** state.

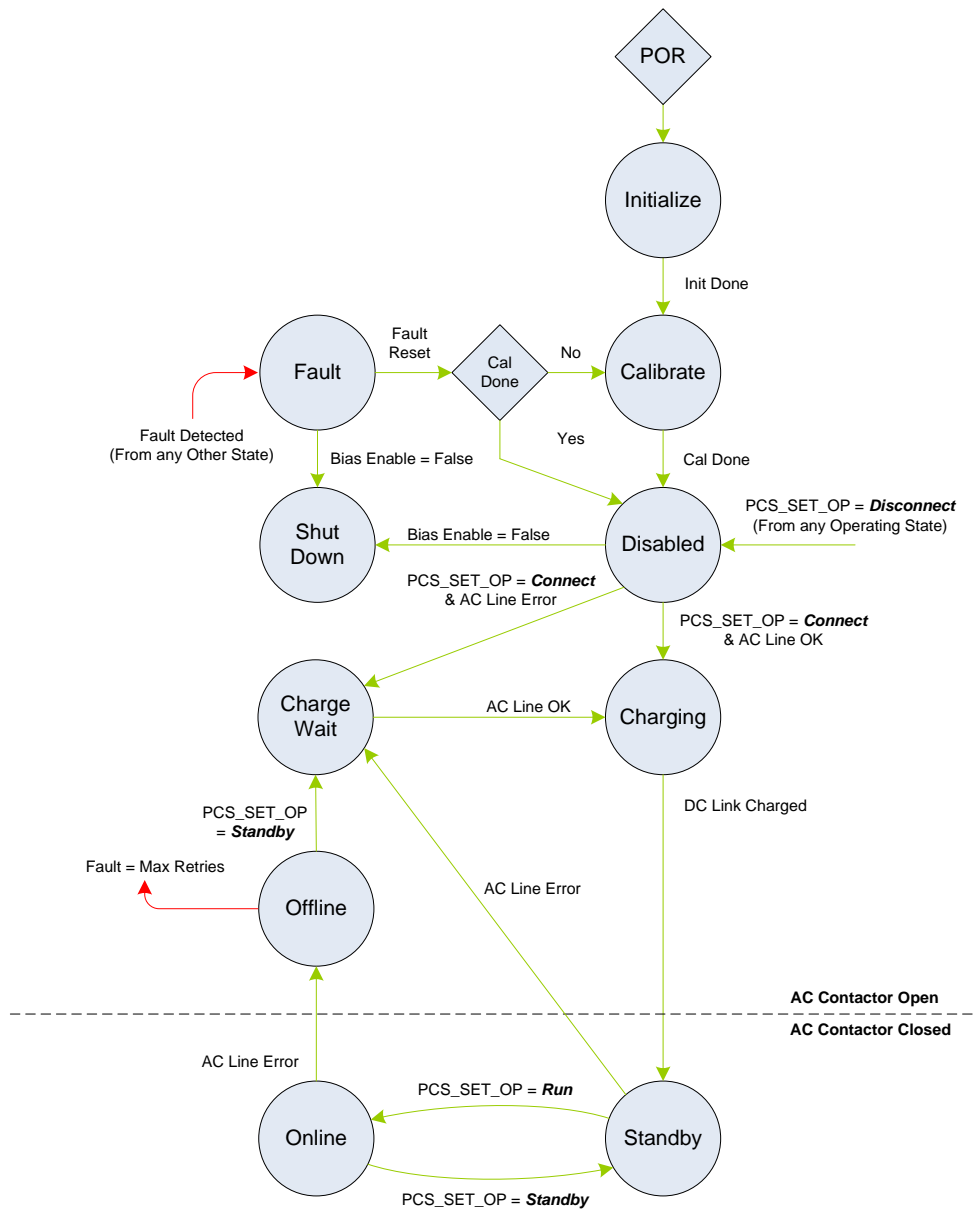

Figure 21 - State Machine

6.7.1 Initialize

The state machine resets to the **Initialize** state following a power-on-reset (POR) event. The firmware is initializing hardware peripherals, configuring variables, and performing self-health tests while in this state. Upon successful initialization, the supply will auto-transition to the **Calibrate** state.

6.7.2 Calibrate

The **Calibrate** state is used to perform calibration of internal sensors and inputs. Following successful calibration, the supply will auto-transition to the **Disabled** state.

6.7.3 Disabled

When in the **Disabled** state, the main AC contactor is open and all power devices are off. The supply will transition to the **Charging** state after receiving a “Connect” command, **REG 40143 – Set Operation = 1**, if the following conditions are met:

1. Main E-Stop input is not active
2. Valid AC Line is detected

If a valid AC line is not detected, the supply will transition to the **Charge Wait** state.

6.7.4 Charge Wait

In the **Charge Wait** state, the supply will monitor the AC line terminals. When a valid AC line connection is detected, based on the “recover” voltage and frequency thresholds, **REG 40242 – 40248**, the supply transitions to the **Charging** state.

6.7.5 Charging

In the **Charging** state, the internal pre-charge circuitry is enabled and the supply waits until the internal DC link has been sufficiently charged. Once the DC link voltage has reached an acceptable level, the supply will transition to the **Standby** state. During this transition, the main AC contactor is closed.

6.7.6 Standby

Once in the **Standby** state the supply is ready for use. A “Run” command, **REG 40143 – Set Operation = 4**, will turn the outputs on and transition to the **Online** State, whereas the “Disconnect” command, **REG 40143 – Set Operation = 2**, returns the supply to the **Disabled** state. If a fault occurs, the AC contactor is opened and the supply transitions to the **Fault** state.

6.7.7 Online

While in the **Online** state the supply is connected to the grid and processing power. If a fault occurs while in this state, the supply will immediately turn OFF, open AC contactor, and transition to the **Fault** state.

If an AC line Error occurs the PCS will transition to the **Offline** state. Otherwise, the supply will remain in this state indefinitely until a “Standby” command **REG 40143 – Set Operation = 3**, or “Disconnect” command **REG 40143 – Set Operation = 2**, is received.

6.7.8 Offline

While in the **Offline** state the supply stops processing power and is disconnected from the grid. The supply will monitor grid conditions, and upon restoration, based on the “recover” voltage

and frequency thresholds, **REG 40242 – 40248**, reconnect and sequence back to the **Online** state. Otherwise, the supply will remain in this state until one of the following occurs:

- A “Standby” command is received, **REG 40143 – Set Operation = 3**
- A “Disconnect” command is received, **REG 40143 – Set Operation = 2**
- The Offline duration exceeds the **REG 40252 – Offline Timeout** period (if > 0)
- A fault occurs.

6.7.9 Fault

If a fault is detected in any of the operating states, the power stage is immediately turned OFF, the AC contactor is opened, and the supply transitions to the **Fault** state. The supply will remain in this state until the latched fault information is explicitly cleared using **REG 40142 – Fault Reset**. If any fault conditions still exist when the fault reset occurs, the supply will remain in the **Fault** state. All attempts to enable or turn the supply on are ignored while in the **Fault** state.

6.7.10 Shutdown

The **Shutdown** state is entered whenever the Bias On/Off discrete input (section 5.2.2.2), is de-asserted. While in the **Shutdown** state, the supply performs various housekeeping tasks before finally disabling the bias supply, shutting itself down.

Note that if the supply happens to be operating, or in any state other than **Fault** or **Disabled** when the Bias On/Off input is de-asserted, the system will automatically sequence to **Disabled** before transitioning to **Shutdown**.

7. Fault and Warning Conditions

The supply provides warning indicators and fault protection in the event of conditions that may cause damage to the equipment or injure personnel. The following sections describe each of the conditions monitored by the supply.

7.1 Warnings

The supply provides the warning indicators listed below. These warning flags do not prohibit operation, and will self-clear, requiring no user intervention. They are reported for informational purposes only. Each warning flag described below is reported in **REG 40131 – Warning Status**. The supply can also indicate a warning by asserting an isolated digital output signal. See section 5.2.3 for details on how to configure the isolated digital outputs.

7.1.1 High Inverter Current – Phase A, B, C

The supply monitors the RMS inverter currents for each of the three phases and will set a flag (one per phase) if the current exceeds the threshold specified by **REG 40192 – AC Over Current**

Warning Threshold. These flags will remain set until the respective current falls below the warning threshold less **REG 40193 – AC Over Current Warning Recover Delta**.

7.1.2 High DC Output Current

The supply monitors the DC output current and will set a flag if the current exceeds the factory configured over current threshold. The flag will automatically reset when the current returns to normal.

7.1.3 High Grid Voltage

The supply monitors the three RMS phase-to-phase AC line voltages and will set a warning flag (one per phase-to-phase voltage) if the voltage exceeds the threshold specified by **REG 40195 – AC Over Voltage Warning Threshold**. These flags will remain set until the respective voltage falls below the warning threshold less **REG 40196 – AC Over Voltage Warning Recover Delta**.

7.1.4 High Output Voltage

The supply monitors the DC output voltage and will set a flag if the voltage exceeds the threshold specified by **REG 40198 – DC Over Voltage Warning Threshold**. The flag will remain set until the voltage falls below the warning threshold less **REG 40199 – DC Over Voltage Warning Recover Delta**.

7.1.5 DC Current Limit

This flag is set whenever the supply is actively limiting the output current due to the load current exceeding the rated output current.

7.1.6 DC Power Limit

This flag is set whenever the maximum output power is limited to a value less than rated. This can be due to either a low output voltage setpoint or low AC line conditions.

7.1.7 PLL Not Locked

The supply monitors the status of the internal phase lock loop (PLL) module that provides synchronization to the AC line and will set a warning flag if the PLL is not locked. This flag is cleared when the PLL regains lock.

7.1.8 High DC/DC Temperature

This flag is set if the DC/DC temperature measurement exceeds a factory configured threshold. These thresholds are not user configurable.

7.1.9 High Inverter Temperature

This flag is set if the inverter temperature measurement exceeds a factory configured threshold. These thresholds are not user configurable.

7.1.10 High Ambient Temperature

The supply measures the internal temperature of the air entering the enclosure and sets this flag if it exceeds a factory configured threshold. These thresholds are not user configurable.

7.1.11 Fan Not Spinning 1,2,3

The supply monitors tachometer feedback from the three cooling fans and will set the respective warning bit if the fan speed is below a factory configured threshold. These bits will remain set, even after the fans have been turned off. Only the successful operation of the fans will clear these bits. These thresholds are not user configurable.

7.1.12 Grid Frequency OOT

This bit is set whenever the supply is offline due to the AC line frequency being out of tolerance.

7.1.13 Grid Voltage AB, BC, CA OOT

These bits are set whenever the supply is offline due to the AC voltages (AB, BC, CA) being out of tolerance (OOT).

7.1.14 Grid Retry Delay

This bit is set during the retry time delay, T_{DELAY} , period of a supply reconnection attempt, as defined in section 6.6.2.

7.1.15 TVS Error

The power supply uses an AC filter when connected to the AC source voltage. This filter contains transient voltage suppression (TVS) devices to protect the supply from voltage spikes that may occur on the AC input. The supply monitors the health of these TVS devices to ensure that they are still working properly. This warning bit will be set and remain latched if one or more of the TVS devices appear to be damaged. This bit may only be cleared by cycling bias power on the supply.

7.2 Faults

The supply provides the fault detection listed below. Whenever a fault occurs the supply will automatically turn the power stage hardware OFF, open the main AC contactor, and transition to the **Fault** state. Any attempt to turn the supply ON while it is in the **Fault** state will be ignored.

Each fault condition is latched and reported in **REG 40129 – Fault Status**. The supply can also indicate the presence of a fault condition by asserting an isolated digital output signal any time one or more latched fault bits are present. See section 5.2.3 for details on how to configure the isolated outputs.

The supply will remain in the **Fault** state and any latched fault flags remain set until explicitly cleared using **REG 40142 – Fault Reset**. Upon receiving the fault reset command, the supply will attempt to clear all latched fault bits. If the faults are successfully cleared, the supply will either transition back to the **Calibrate** state or the **Disabled** state, depending on the status of the power-on calibration routines. If any faults fail to clear, their respective fault flags will remain latched, and the supply remains in the **Fault** state.

7.2.1 H/W and S/W Inverter Over-Current A, B, C

The supply provides fast hardware protection for inverter over current conditions. It also monitors the RMS inverter currents for each of the three phases and will fault if any of the currents exceed the threshold specified by **REG 40191 – AC Over Current Fault Threshold**.

7.2.2 DC Output Over-Current

The supply monitors the DC output current and will fault if it exceeds the factory configured threshold.

7.2.3 Grid Over-Voltage AB, BC, CA

The supply monitors the RMS line-to-line grid voltage for phases AB, BC, and CA, and will fault if any of the voltages exceed the threshold specified by **REG 40194 – AC Over Voltage Fault Threshold** while the AC contactor is closed.

7.2.4 H/W and S/W DC Output Over-Voltage

The supply provides fast hardware protection for DC output over-voltage conditions. It also monitors the DC output voltage and will fault if it exceeds the threshold specified by **REG 40197 – DC Over Voltage Fault Threshold**.

7.2.5 PLL Lost Lock

The supply monitors the status of the internal phase lock loop (PLL) module that is providing synchronization to the AC line. A fault is asserted if the PLL loses lock while the supply is ON.

7.2.6 Over Temperature

This bit is set if the internal temperature of the supply reaches the factory fault threshold.

7.2.7 Emergency Stop

The supply will assert a fault if the ESTOP hardware input is not actively driven.

7.2.8 Communications Heartbeat Fault

The supply expects the system controller to increment **REG 40141 – Controller Heartbeat** every second, with periodic resets to zero. The supply will monitor this register and assert the fault if it hasn't incremented by 1, or been reset to zero, within a 2sec period. The timeout monitor isn't armed until the first write to **REG 40141** following a POR.

7.2.9 Power Down Error

This fault bit is set if the supply fails to power down when the "Bias On/Off" discrete input was de-asserted.

7.2.10 Invalid User Configuration

This bit indicates that the user has set an invalid configuration register or combination of registers. If this bit is set, see **REG 40169 – User Configuration Error Status** to determine the offending register(s).

7.2.11 Invalid Model

This bit is set if the loaded product configuration is not compatible with the supply hardware model. Please consult Oztek for the proper configuration file.

7.2.12 Offline Max Retry

This bit is set if the maximum number of retry attempts, defined by **REG 40250 – Offline Retry Count**, has been exceeded. See section 6.6.2 for detailed information.

7.2.13 Offline Timeout

This bit is set if supply remains in the **Offline** state for longer than the time defined by **REG 40252 – Offline Timeout**. See section 6.6.2 for detailed information.

7.2.14 Factory Fault

This bit is set any time one or more internal factory faults occur in the PCS. **REG 40133 – Factory Fault Status** can be read to determine the source of the offending fault(s). In general, these factory fault conditions are related to circuitry internal to the PCS and should rarely occur unless there are hardware failures within the PCS or if very abnormal conditions occur outside the PCS. If the PCS is consistently reporting any of these conditions, contact Oztek technical support to discuss the appropriate course of action. Each of the factory faults is briefly described below in order to assist in this discussion.

- **H/W and S/W DC Over-Current (A/B/C, top/bot)** – The PCS uses a multi-phase DC/DC converter to boost the DC input voltage up to the desired internal DC link voltage used by the inverter. These fault bits are used to indicate over-current conditions within the DC/DC converter phases.
- **DC Current Imbalance (A/B/C)** – These bits are used to indicate an imbalance condition within the three DC/DC converter phases.
- **DC Link Over Voltage (H/W top/bot and S/W)** – The PCS provides hardware-based over voltage protection for each internal DC link voltage (top and bottom), as well as software-based protection for the total combined link voltage. These bits are set any time one of these over voltage conditions occur.
- **DC Link Voltage Imbalance** – This fault occurs if the difference between the top and bottom DC Link voltages exceed the maximum imbalance threshold.
- **Pre-Charge Timeout** – The PCS contains circuitry to charge the internal DC link voltage above the rectified AC input voltage prior to closing the AC contactor (i.e., while the PCS is in the **Charging** state). If the DC link voltage fails to charge within the expected timeframe, the pre-charge operation will be terminated, and this fault bit will be set.
- **Bias Under Voltage** – The PCS generates its internal control bias supply from the AC input voltage. If this internal bias supply ever drops below the minimum operating voltage, this fault bit will be set.
- **DC/DC Communication Error** – This fault bit will be set if any internal communications errors occur.
- **Datalog Error** – Datalogging information (discussed in section 9) is stored in non-volatile FLASH memory on the PCS controller. This fault bit is set whenever the PCS experiences an error when updating this FLASH memory, indicating possible corruption or loss of datalogging information.
- **Invalid Factory Configuration** – The PCS controller uses a non-volatile memory device for storing factory information specific to each unit, such as serial number and model information. This fault bit is set whenever the PCS experiences an error when reading or writing this memory, indicating the possible corruption of the factory information.
- **Configuration EEPROM Error** – This fault is fault bit is set whenever the PCS experiences an error when reading or writing configuration memory, indicating the possible corruption of the configuration settings. Note – frequently/cyclically modifying PCS configuration parameters can lead to memory device failure, resulting in this fault (see section 11.1.2 for details on which registers are allowed to be updated frequently/cyclically).
- **Calibration Error** – Following a power-on reset, the PCS will perform a self-calibration of various internal sensors. This bit is will be set if the calibration correction for one or more of the sensors exceeds the maximum expected limits, indicating that one or more of the hardware sense circuits may be damaged.

8. Real Time Clock (RTC)

The supply provides a real-time clock (RTC) function to allow recording of elapsed times as well as time stamping data log values.



CAUTION

The RTC needs to be set each time the supply is powered on. Prior to each shutdown, the present time and date is stored in non-volatile memory. Upon a POR, the RTC will resume time/date keeping from this point until it is set by the user. See section 8.3 for information on setting the date and time.

8.1 Real Time Clock – Date Format

The RTC date is stored as a 32-bit data word with the following format:

Bits 31 - 24	Bit 23 – 16	Bit 15 - 14	Bit 13 - 0
Day	Month	n/a	Year

8.2 Real Time Clock – Time Format

The RTC clock time is stored as a 32-bit data word with the following format:

Bits 31 - 24	Bit 23 – 16	Bit 15 - 8	Bit 7 - 0
n/a	Seconds	Minutes	Hours

8.3 Setting the Date and Time

For synchronization purposes, the data and time must always be set together. **REG 40413 – RTC Set Date** must be written to first, followed by a write to **REG 40415 – RTC Set Time**. See section 11.2.9 for register details.

8.4 Reading the Date and Time

For synchronization purposes, the data and time must always be read together. **REG 40417 – RTC Get Date** must be read first, followed by a read of **REG 40419 – RTC Get Time**. See section 11.2.9 for register details.

9. Data Logging

The supply provides three types of data logging activities as described in the following paragraphs. *Event Data Logging* captures operating parameters on a fault or user configured trigger event. *Fault History Logs* provide time stamp and event counters for each fault source. *Operating History Logs* provide cumulative time spent operating under a variety of conditions as well as min/max values for critical parameters.

9.1 Event Data Logging

The Event Data Logging feature is intended to capture operating data leading up to, and shortly after an event. Events can be the assertion of a system fault or a user configured “trigger” event. For a detailed explanation of data types, please see sections 11.1.3 - 11.1.9.

Table 9 - Data Logging Parameters

Param #	Data Log Buffer Addr	Buffer Offset	Data Type	Parameter	Units
0	40460	0	U16	Power Supply State	Enum
1	40461-40462	1	U32	Power Supply Faults	Bitfield
2	40463-40464	3	U32	Power Supply Warnings	Bitfield
3	40465	5	U16	DC Voltage	0.1V
4	40466	6	S16	DC Current	0.1 A
5	40467	7	U16	RMS Grid Voltage – Phase AB	0.1 V _{RMS}
6	40468	8	U16	RMS Grid Voltage – Phase BC	0.1 V _{RMS}
7	40469	9	U16	RMS Grid Voltage – Phase CA	0.1 V _{RMS}
8	40470	10	U16	RMS Grid Voltage – Phase A	0.1 V _{RMS}
9	40471	11	U16	RMS Grid Voltage – Phase B	0.1 V _{RMS}
10	40472	12	U16	RMS Grid Voltage – Phase C	0.1 V _{RMS}
11	40473	13	U16	RMS Grid Current – Phase A	0.1 A _{RMS}
12	40474	14	U16	RMS Grid Current – Phase B	0.1 A _{RMS}
13	40475	15	U16	RMS Grid Current – Phase C	0.1 A _{RMS}
14	40476	16	S16	Grid Real Power - P	10 W
15	40477	17	S16	Grid Reactive Power – Q	10 VAR
16	40478	18	U16	Grid Frequency	0.01 Hz
17	40479	19	S16	Grid Power Factor	0.1 %
18	40480	20	S16	DC/DC Module – Temp Phase A	0.1 °C
19	40481	21	S16	DC/DC Module – Temp Phase B	0.1 °C
20	40482	22	S16	DC/DC Module – Temp Phase C	0.1 °C
21	40483	23	S16	Inverter Module – Temp Phase A	0.1 °C
22	40484	24	S16	Inverter Module – Temp Phase B	0.1 °C
23	40485	25	S16	Inverter Module – Temp Phase C	0.1 °C
24	40486	26	S16	Ambient Temp	0.1 °C
25	40487	27	U16	Command – DC Voltage	0.1 V
26	40488	28	S16	Command – DC Current	0.1 A
27	41489	29	S16	Command – Grid Real Current D	0.1 A

28	41490	30	S16	Command – Grid Reactive Current Q	0.1 A
29	41491	31	S16	AC Real Current D	0.1 A
30	41492	32	S16	AC Reactive Current Q	0.1 A
31	41493	33	S16	AC Voltage – D	0.1 V
32	41494	34	S16	AC Voltage – Q	0.1 V
33	41495	35	U16	Inverter Current – Phase A	0.1 A _{RMS}
34	41496	36	U16	Inverter Current – Phase B	0.1 A _{RMS}
35	41497	37	U16	Inverter Current – Phase C	0.1 A _{RMS}
36	41498	38	S16	Inverter Real Current D	0.1 A
37	41499	39	S16	Inverter Reactive Current Q	0.1 A
38	41500	40	S16	Inverter Voltage – D	0.1 V
39	41501	41	S16	Inverter Voltage – Q	0.1 V
40	41502	42	S16	DC Current – Top A	0.1 A
41	41503	43	S16	DC Current – Top B	0.1 A
42	41504	44	S16	DC Current – Top C	0.1 A
43	41505	45	S16	DC Current – Bottom A	0.1 A
44	41506	46	S16	DC Current – Bottom B	0.1 A
45	41507	47	S16	DC Current – Bottom C	0.1 A
46	41508	48	U16	DC Link Voltage	0.1 V
47	41509	49	U16	DC Link Voltage – Top	0.1 V
48	41510	50	U16	DC Link Voltage – Bottom	0.1 V
49	41511	51	U16	Bias Voltage	0.01 V
50	41512-41513	52	U32	Factory Faults	Bitfield
51	41514-41515	54	U32	Inverter Warnings	Bitfield
52	41516-41517	56	U32	DC/DC Warnings	Bitfield
53	41518	58	U16	DC/DC State	Enum

9.1.1 Fault Events

The data logging parameters defined in Table 9 are sampled at the factory configured rate defined in **REG 40421 – Fault Log Sample Period**, and continuously buffered to RAM. When a fault event occurs, post trigger data is collected, after which the buffer is frozen and written to non-volatile memory. The power supply can store up to 12 buffers. The buffers are circular, such that a new fault event will cause the oldest buffer to be over written with the new data.

To read the fault logs, the user should first read **REG 40422 – Fault Log - # of Available Logs** to determine how many logs contain valid data. Assuming one or more logs are valid, the user would then select the desired log to be read by writing to **REG 40425 – Fault Log - Select Log**. Note that this register is 0 based, where 0 corresponds to the oldest fault event and 11 to the newest. For example, if **REG 40422** = 4, there are 4 available logs; to read the oldest set **REG 40425** = 0.

Once the desired log has been selected, the header information can be read by writing a “1” to **REG 40426 – Fault Log - Get Header**, followed by a read of **Data Log Buffer Registers 40460 –**

40467. Table 10 defines the header data and format as read from the Data log buffer registers along with example data.

Table 10 - Fault Log Header Data Description

Data Log Read Buffer Address	Header Data Description	Example	Notes
40460	Time Stamp (MSW)	0x0000	e.g. = 1:48pm, see section 8.2 for details on time format
40461	Time Stamp (LSW)	0x300D	
40462	Date Stamp (MSW)	0x1503	e.g. = 3/21/2017, see section 8.1 for details on date format
40463	Date Stamp (LSW)	0x07E1	
40464	Sample Record Count	3223	
40465	Words per Record	59	
40466	Sample Period (ms)	1	Time between each record
40467	# of Post Trigger Samples	64	

In this example, the fault occurred at 1:48pm on 3/2/2017. There are 3,223 sample records, each containing 59 16-bit words. The sample records were logged at 1ms intervals, and the last 64 records were logged after the fault occurred. Table 11 illustrates how this example buffer is organized.

Table 11 - Fault Log Buffer Organization

		Data Log Read Buff Address			
		40460	40518	
		Parameter			
		Supply State	DC/DC State	Time
Pre-Fault Data →	Record 0	Supply State ₀	DC/DC State ₀	-3.158 sec
	Record 1	Supply State ₁	DC/DC State ₁	-3.157 sec
	
Fault Data →	Record 3158	Supply State ₃₁₅₈	DC/DC State ₃₁₅₈	0 sec
	Record 3159	Supply State ₃₁₅₉	DC/DC State ₃₁₅₉	1 ms
Post-Fault Data →	
	
	Record 3222	Supply State ₃₂₂₂	DC/DC State ₃₂₂₂	64 ms

With the header information, it is now possible to read as much or as little of the Fault Log as desired. Each record in the buffer is read individually by first writing the record number to **REG 40427 – Fault Log - Get Selected Record**, and then reading the selected data from the corresponding **Data Log Buffer Registers**.

9.1.2 User Events

User Event data logging is intended to capture operating data leading up to and/or after a trigger event. The data logging parameters defined in Table 9 are available for capture. The selected parameters are sampled at a user-configured sampling rate and continuously buffered to RAM. When a trigger event occurs, the buffer is frozen or filled, depending on the configuration.

9.1.2.1 Selecting Parameters

The user may select one or more of the data logging parameters defined in Table 9 by writing to **REG 40432/40434 - User Log Variable Selection (LSW/MSW)**. These are two 32-bit registers where each bit can be considered an “enable” for the corresponding parameter in Table 9. The LSW register contains enable bits 0 – 31. The MSW register contains enable bits 32 – 63. Writing a “1” to specific bit positions means that the corresponding parameters will be captured.

Table 12 - User Log Variable Selection Bit Assignment

Bit	Parameter Name
0	Supply State
1	Supply Faults
·	·
·	·
·	·
52	DC/DC Warnings
53	DC/DC State
54 - 63	Reserved for Future Use

As an example, if the user wished to capture Supply Faults, DC Voltage, and DC Current, they would write 0x0000001A to register 40432, and to capture Inverter Current Phase A, DC Current Top A, and DC Link Voltage they would write 0x00004102 to register 40434.

9.1.2.2 Setting the Sample Period and Post Trigger Size

The user can set the sample period by writing to **REG 40431 - User Log Sample Period**. Note that the User Event Log is fixed at 63,744 words. As a result, the number and size of the selected parameters, together with the sample period, will define the time duration of the captured data according to:

$$Duration = \frac{63,744 \text{ words}}{K \text{ words/sample}} \times SamplePeriod$$

As an example, assume **REG 40432 - User Log Variable Selection** = 0x0000001A to log supply Faults, DC Voltage, and DC Current. Referencing Table 9, the number of words per sample, K, would be 4 since DC Voltage and DC Current are U16 parameters and supply Faults is U32.

If **REG 40431 - User Log Sample Period** = 10msec, then 2.656 minutes worth of data will be captured. If instead a 1 second sample period were used, then 4 hours, 25 minutes, and 36 seconds of data would be captured.

The user can also configure how much of the log is dedicated to post trigger information using **REG 40430 - User Log Post Trigger Percentage**. This register is in units of %, so setting it to 0 would mean the entire log represents the time before the trigger event. A setting of 50% would mean half of the log occurred before the trigger and half after, while 100% implies all the log occurred after the trigger.

9.1.2.3 Configuring the Trigger Mode

The supply supports four trigger modes, as described below, by setting **REG 40436- User Log Trigger Mode** accordingly.

- | | |
|-----------------------------------|---|
| Mode 0: Continuous Trigger | Sampling is only controlled by REG 40429 - User Log Start/Stop . When register 40429 = 1, the selected parameters will be continuously sampled at the configured rate. The buffer is circular, so once filled, the oldest data will be overwritten with the latest sample. |
| Mode 1: Single Trigger | Sampling is controlled by REG 40429 - User Log Start/Stop as well as Trigger 1. Register 40429 must equal 1 and the Trigger 1 conditions must be True for the trigger to be asserted. |
| Mode 2: Dual OR Trigger | Sampling is controlled by REG 40429 - User Log Start/Stop as well as both Trigger 1 and 2. Register 40429 must equal 1 and either Trigger 1 conditions OR Trigger 2 conditions must be True for the trigger to be asserted. |
| Mode 3: Dual AND Trigger | Sampling is controlled by REG 40429 - User Log Start/Stop as well as both Trigger 1 and 2. Register 40429 must equal 1 and both Trigger 1 conditions AND Trigger 2 conditions must be True for the trigger to be asserted. |

9.1.2.4 Configuring Triggers

The power supply provides two user triggers. When configured for Single Trigger mode, only Trigger 1 is used. Dual OR and Dual AND modes require both Trigger 1 and Trigger 2. Each trigger is configured by first selecting a parameter to trigger on. This is done using **REG 40438(40444) - User Log Trigger1(2) Variable Selection**. The value written to these registers corresponds to the parameter number in Table 9. For example, to trigger on the power supply Faults, the register should be set to "1". To trigger on DC Voltage the register should be set to "3".

The value in **REG 40439(40445) - User Log Trigger1(2) Value Mask** is logically AND'ed (bit-wise) with the selected variable. The main purpose of this register is to allow selection of a bit within a bit-field register as the trigger source. For example, the H/W DC Over Voltage fault is bit 10 of the power supply Faults register. To use this bit as a trigger source, the mask register would be set to 0x00000400. See section 11.2.3 for a complete list of the various fault and warning bits and their corresponding register bit positions. Note that the mask is always applied and should be set to 0xFFFFFFFF if no masking is required.

To generate the trigger condition, the power supply compares the value of the masked, selected parameter to **REG 40441(40447) - User Log Trigger1(2) Trigger Value**. **REG 40437(40443) - User Log Trigger1(2) Compare Type** defines the type of compare to be used:

0 =	Less than (<)	Masked Parameter < Register 40441(40447)
1 =	Greater Than (>)	Masked Parameter > Register 40441 (40447)
2 =	Equal to (=)	Masked Parameter = Register 40441 (40447)
3 =	Not Equal to (!=)	Masked Parameter != Register 40441 (40447)

As an example, to trigger on the H/W DC Over Voltage Fault bit being asserted OR the DC Voltage being greater than 600V, the following register settings would be used:

Table 13 - User Log Trigger Configuration Example

Reg #	Reg Name	Value	Description
40436	Trigger Mode	2	Dual OR Trigger
40438	Trigger1 Variable Selection	1	Supply Faults
40439	Trigger1 Value Mask	0x00000400	Select H/W DC Over Voltage Fault bit
40437	Trigger1 Compare Type	2	Equal to
40441	Trigger1 Trigger Value	0x00000400	H/W DC Over Voltage Fault bit asserted
40444	Trigger2 Variable Selection	3	DC Voltage
40445	Trigger2 Value Mask	0xFFFFFFFF	No masking
40443	Trigger2 Compare Type	1	Greater than
40447	Trigger2 Trigger Value	6000	600V with 0.1V scaling

9.1.2.5 Reading the Log

REG 40449 – User Log Status can be read to determine the status of the logger. A value of 1 or 2 means the logger is either waiting for a trigger or in the middle of capturing data. A value of 3 means the logger has finished capturing data and that it is available to be read.

To read the log, the user should first read the header information by writing a “1” to **REG 40450 – User Log Get Header**, followed by a read of **Data Log Buffer Registers 40460 – 40471**. Table 14 defines the header data and format as read from the Data log buffer registers along with example data.

Table 14 - User Log Header Data Description

Data Log Read Buffer Address	Header Data Description	Example	Notes
40460	Time Stamp (MSW)	0x0000	e.g. = 1:48pm, see section 8.2 for details on time format
40461	Time Stamp (LSW)	0x300D	
40462	Date Stamp (MSW)	0x1503	e.g. = 3/21/2017, see section 8.1 for details on date format
40463	Date Stamp (LSW)	0x07E1	
40464	Selected User Vars, bits [31:16]	0x0000	Supply Faults, DC Voltage, DC Current selected
40465	Selected User Vars, bits [15:0]	0x001A	
40466	Selected User Vars, bits [63:48]	0x0000	No variables selected
40467	Selected User Vars, bits [47:32]	0x0000	
40468	Sample Count	15,936	
40469	Words per Sample	4	
40470	Sample Period (ms)	10	Time between each record
40471	# of Post Trigger Samples	3,984	

In this example, the trigger occurred at 1:48pm on 3/2/2017. There are 15,936 samples, each containing 4 16-bit words. The samples were logged at 10msec intervals, and the last 3,984 samples were taken after the trigger occurred. Table 11 illustrates how this example buffer is organized.

Table 15 - User Log Buffer Organization

		Data Log Read Buff Address			Time
		40460 - 40461	40462	40463	
		Parameter			Time
		Supply Fault	DC Voltage	DC Current	
Pre-Trigger Data →	Sample 0	Supply Fault ₀	DC V ₀	DC Curr ₀	-1.991 min
	Sample 1	Supply Fault ₁	DC V ₁	DC Curr ₁	-1.990 min
	
Trigger Data →	Sample 11951	Supply Fault ₁₁₉₅₁	DC V ₁₁₉₅₁	DC Curr ₁₁₉₅₁	0 min
	Sample 11952	Supply Fault ₁₁₉₅₂	DC V ₁₁₉₅₂	DC Curr ₁₁₉₅₂	10 ms
Post-Trigger Data →	
	
	Sample 15,935	Supply Fault ₁₅₉₃₅	DC V ₁₅₉₃₅	DC Curr ₁₅₉₃₅	39.84 sec

With the header information, it is now possible to read as much or as little of the User Log as desired. Each record in the buffer is read individually by first writing the sample number to **REG 40451 – User Log - Get Selected Sample Data**, and then reading the selected data from the corresponding **Data Log Buffer Registers**.

9.2 Fault History Log

9.2.1 Fault Count Log

The power supply keeps track of the total number of occurrences for each of the faults defined in **REG 40129 – Fault Status**. Each of the faults has an associated 16-bit counter organized as illustrated in Table 16.

Table 16 - Fault Count Buffer Organization

Index	Counter	Fault
0	Count – Fault Bit 0	H/W Over Current A
1	Count – Fault Bit 1	H/W Over Current B
.	.	.
.	.	.
.	.	.
28	Count – Fault Bit 28	Offline Timeout Fault

The user may read a single fault count or the entire buffer using **REG 40457 – Operation Log - Read Fault Counts**. This is a 16-bit register in which the LSB is used to specify the index of the first count to be read, and the MSB specifies the # of counters to read. After writing to register 40457, the counter(s) can be read from the corresponding **Data Log Buffer Registers**.

For example, to read all the counts, write 0x1D00 to register 40457 and then read registers 40460 to 40488. The read buffer will be organized as follows:

Read Buffer Address	Counter
40460	Count – Fault Bit 0
40461	Count – Fault Bit 1
.	.
.	.
.	.
40488	Count – Fault Bit 28

To read a single count, say the H/W Over Current B count, write 0x0101 to register 40457 and then read register 40460.

9.2.2 Fault Time Stamp Log

The power supply records the date and time of the last six occurrences for each of the possible faults. Each of the time and date values is a 32-bit value, formatted according to sections 8.1 and 8.2.

The fault time stamp history buffers can be accessed by first specifying the fault by writing the bit location, as specified in **REG 40129 – Fault Status**, to **REG 40452 – Fault History Log - Set Fault Index**. **REG 40453 – Fault History Log - # of Entries for Specified Fault** can then be read to determine how many, if any, fault occurrences have been logged, i.e., 0 through 6.

Writing a “1” to **REG 40454 – Fault History Log - Get History Data for Specified Fault** will load the fault history into the **Data Log Buffer Registers**. Table 17 illustrates how the time stamp history buffer data is arranged within the read buffer. Note that the buffer is always loaded with six time and date stamps. The user must read **REG 40453 – Fault History Log - # of Entries for Specified Fault** to determine which, if any, are valid.

Table 17 - Fault History Buffer Arrangement

Data Log Buffer Address		Fault Occurrence
40460	MSW	1 st Occurrence – Date - Oldest
40461	LSW	
40462	MSW	1 st Occurrence – Time - Oldest
40463	LSW	
40464	MSW	2 nd Occurrence – Date
40465	LSW	
40466	MSW	2 nd Occurrence – Time
40467	LSW	
40468	MSW	3 rd Occurrence – Date
40469	LSW	
40470	MSW	3 rd Occurrence – Time
40471	LSW	
40472	MSW	4 th Occurrence – Date
40473	LSW	
40474	MSW	4 th Occurrence – Time
40475	LSW	
40476	MSW	5 th Occurrence – Date
40477	LSW	
40478	MSW	5 th Occurrence – Time
40479	LSW	
40480	MSW	6 th Occurrence – Date - Most Recent
40482	LSW	
40483	MSW	6 th Occurrence – Time - Most Recent
40484	LSW	

9.3 Operating History Logs

The operating history log is intended to record critical operating parameters over the life of the power supply. This data includes operating time, and min/max values of critical parameters, as detailed in the following sections.

9.3.1 Operating Time Log

The power supply keeps track of the cumulative time spent operating under a variety of conditions as defined in Table 18. Each counter is 32 bits long where each count represents 1 second.

Table 18 - Operating Time Parameter Log

Parameter Index	Parameters Units = Sec, Data Type = U32
0	Factory Data
1	Factory Data
2	Time Powered On
3	Time in Fault State
4	Time in Disabled State
5	Time in Charge Wait State
6	Time in Charging State
7	Time in Standby State
8	reserved
9	Time in On-Line State
10	Time in Off-Line State
11	reserved
12	reserved
13	reserved
14	Time in Power Down State
15	Time in Test Mode State
16	Time Operating: $T_{DC/DC} < 10\text{ }^{\circ}\text{C}$
17	Time Operating: $10 < T_{DC/DC} < 20\text{ }^{\circ}\text{C}$
18	Time Operating: $20 < T_{DC/DC} < 30\text{ }^{\circ}\text{C}$
19	Time Operating: $30 < T_{DC/DC} < 40\text{ }^{\circ}\text{C}$
20	Time Operating: $40 < T_{DC/DC} < 50\text{ }^{\circ}\text{C}$
21	Time Operating: $50 < T_{DC/DC} < 60\text{ }^{\circ}\text{C}$
22	Time Operating: $60 < T_{DC/DC} < 70\text{ }^{\circ}\text{C}$
23	Time Operating: $70 < T_{DC/DC} < 80\text{ }^{\circ}\text{C}$
24	Time Operating: $80 < T_{DC/DC} < 90\text{ }^{\circ}\text{C}$
25	Time Operating: $T_{DC/DC} > 90\text{ }^{\circ}\text{C}$
26	Time Operating: $T_{INV} < 10\text{ }^{\circ}\text{C}$
27	Time Operating: $10 < T_{INV} < 20\text{ }^{\circ}\text{C}$
28	Time Operating: $20 < T_{INV} < 30\text{ }^{\circ}\text{C}$
29	Time Operating: $30 < T_{INV} < 40\text{ }^{\circ}\text{C}$
30	Time Operating: $40 < T_{INV} < 50\text{ }^{\circ}\text{C}$
31	Time Operating: $50 < T_{INV} < 60\text{ }^{\circ}\text{C}$
32	Time Operating: $60 < T_{INV} < 70\text{ }^{\circ}\text{C}$
33	Time Operating: $70 < T_{INV} < 80\text{ }^{\circ}\text{C}$
34	Time Operating: $80 < T_{INV} < 90\text{ }^{\circ}\text{C}$
35	Time Operating: $T_{INV} > 90\text{ }^{\circ}\text{C}$
36	Time Operating: $T_{ENC} < 10\text{ }^{\circ}\text{C}$
37	Time Operating: $10 < T_{ENC} < 20\text{ }^{\circ}\text{C}$

Parameter Index	Parameters Units = Sec, Data Type = U32
38	Time Operating: $20 < T_{ENC} < 30$ °C
39	Time Operating: $30 < T_{ENC} < 40$ °C
40	Time Operating: $40 < T_{ENC} < 50$ °C
41	Time Operating: $50 < T_{ENC} < 60$ °C
42	Time Operating: $60 < T_{ENC} < 70$ °C
43	Time Operating: $70 < T_{ENC} < 80$ °C
44	Time Operating: $80 < T_{ENC} < 90$ °C
45	Time Operating: $T_{ENC} > 90$ °C
46	Time Operating: $V_{DC_IN} < 300$ V
47	Time Operating: $300 < V_{DC} < 350$ V
48	Time Operating: $350 < V_{DC} < 400$ V
49	Time Operating: $400 < V_{DC} < 450$ V
50	Time Operating: $450 < V_{DC} < 500$ V
51	Time Operating: $500 < V_{DC} < 550$ V
52	Time Operating: $550 < V_{DC} < 600$ V
53	Time Operating: $600 < V_{DC} < 650$ V
54	Time Operating: $650 < V_{DC} < 700$ V
55	Time Operating: $700 < V_{DC} < 750$ V
56	Time Operating: $750 < V_{DC} < 800$ V
57	Time Operating: $800 < V_{DC} < 850$ V
58	Time Operating: $V_{DC} > 850$ V
59	Time Operating: $I_{DC} < -80$ A
60	Time Operating: $-80 < I_{DC} < -60$ A
61	Time Operating: $-60 < I_{DC} < -40$ A
62	Time Operating: $-40 < I_{DC} < -20$ A
63	Time Operating: $-20 < I_{DC} < 0$ A
64	Time Operating: $0 < I_{DC} < 20$ A
65	Time Operating: $20 < I_{DC} < 40$ A
66	Time Operating: $40 < I_{DC} < 60$ A
67	Time Operating: $60 < I_{DC} < 80$ A
68	Time Operating: $I_{DC} > 80$ A
69	Time Operating: $V_{AC} < 200$ V _{RMS}
70	Time Operating: $200 < V_{AC} < 250$ V _{RMS}
71	Time Operating: $250 < V_{AC} < 300$ V _{RMS}
72	Time Operating: $300 < V_{AC} < 350$ V _{RMS}
73	Time Operating: $350 < V_{AC} < 400$ V _{RMS}
74	Time Operating: $400 < V_{AC} < 450$ V _{RMS}
75	Time Operating: $450 < V_{AC} < 500$ V _{RMS}
76	Time Operating: $V_{AC} > 500$ V _{RMS}
77	Time Operating: $0 < I_{AC} < 5$ A _{RMS}

Parameter Index	Parameters Units = Sec, Data Type = U32
78	Time Operating: $5 < I_{AC} < 10 A_{RMS}$
79	Time Operating: $10 < I_{AC} < 15 A_{RMS}$
80	Time Operating: $15 < I_{AC} < 20 A_{RMS}$
81	Time Operating: $20 < I_{AC} < 25 A_{RMS}$
82	Time Operating: $25 < I_{AC} < 30 A_{RMS}$
83	Time Operating: $30 < I_{AC} < 35 A_{RMS}$
84	Time Operating: $35 < I_{AC} < 40 A_{RMS}$
85	Time Operating: $40 < I_{AC} < 45 A_{RMS}$
86	Time Operating: $I_{AC} > 45 A_{RMS}$
87	Time Operating: $P < -35 kW$
88	Time Operating: $-35 < P < -30 kW$
89	Time Operating: $-30 < P < -25 kW$
90	Time Operating: $-25 < P < -20 kW$
91	Time Operating: $-20 < P < -15 kW$
92	Time Operating: $-15 < P < -10 kW$
93	Time Operating: $-10 < P < -5 kW$
94	Time Operating: $-5 < P < 0 kW$
95	Time Operating: $0 < P < 5 kW$
96	Time Operating: $5 < P < 10 kW$
97	Time Operating: $10 < P < 15 kW$
98	Time Operating: $15 < P < 20 kW$
99	Time Operating: $20 < P < 25 kW$
100	Time Operating: $25 < P < 30 kW$
101	Time Operating: $30 < P < 35 kW$
102	Time Operating: $P > 35 kW$
103	Time Operating: $I_{AC} < 25 A_{RMS}$ and $T_{ENC} < 30 ^\circ C$
104	Time Operating: $I_{AC} < 25 A_{RMS}$ and $30 < T_{ENC} < 40 ^\circ C$
105	Time Operating: $I_{AC} < 25 A_{RMS}$ and $40 < T_{ENC} < 50 ^\circ C$
106	Time Operating: $I_{AC} < 25 A_{RMS}$ and $50 < T_{ENC} < 60 ^\circ C$
107	Time Operating: $I_{AC} < 25 A_{RMS}$ and $T_{ENC} > 60 ^\circ C$
108	Time Operating: $I_{AC} > 25 A_{RMS}$ and $T_{ENC} < 30 ^\circ C$
109	Time Operating: $I_{AC} > 25 A_{RMS}$ and $30 < T_{ENC} < 40 ^\circ C$
110	Time Operating: $I_{AC} > 25 A_{RMS}$ and $40 < T_{ENC} < 50 ^\circ C$
111	Time Operating: $I_{AC} > 25 A_{RMS}$ and $50 < T_{ENC} < 60 ^\circ C$
112	Time Operating: $I_{AC} > 25 A_{RMS}$ and $T_{ENC} > 60 ^\circ C$

The user may read a single operating time or up to a maximum of 32 times by using **REG 40456 – Operation Log - Read Time Variables**. This is a 16-bit register in which the LSB is used to specify the index of the first time to be read, and the MSB specifies the # of times to read. After

writing to register 40456, the times can be read from the corresponding **Data Log Buffer Registers**.

For example, to read “Time Operating: P > 35 kW”, write 0x0166 to register 40456 and then read registers 40460 and 40461 for the 32-bit time in seconds, where 40460 holds the MSW and 40461 the LSW.

To read the three consecutive times: Time Powered on, Time in Fault State, Time in Disabled State, write 0x0302 to register 40456 and then read registers 40460 to 40465. The read buffer will be organized as follows:

Data Log Buffer Address		Operating Time
40460	MSW	Time Powered On
40461	LSW	
40462	MSW	Time in Fault State
40463	LSW	
40464	MSW	Time in Disabled State
40465	LSW	

9.3.2 Min/Max Log

The power supply keeps track of minimum and maximum values for the parameters listed in Table 19.

Table 19 - Min/Max Parameter Log

Parameter Index	Parameters	Units	Data Type
0	Max – AC Voltage Phase AB	0.1 V _{RMS}	U16
1	Max – AC Voltage Phase BC	0.1 V _{RMS}	U16
2	Max – AC Voltage Phase CA	0.1 V _{RMS}	U16
3	Max – AC Voltage Phase A	0.1 V _{RMS}	U16
4	Max – AC Voltage Phase B	0.1 V _{RMS}	U16
5	Max – AC Voltage Phase C	0.1 V _{RMS}	U16
6	Max – AC Current Phase A	0.1 A _{RMS}	U16
7	Max – AC Current Phase B	0.1 A _{RMS}	U16
8	Max – AC Current Phase C	0.1 A _{RMS}	U16
9	Max – Inverter Current Phase A	0.1 A _{RMS}	U16
10	Max – Inverter Current Phase B	0.1 A _{RMS}	U16
11	Max – Inverter Current Phase C	0.1 A _{RMS}	U16
12	Max – Real AC Power (P)	10 W	S16
13	Max – Reactive AC Power (Q)	10 VAR	S16
14	Max – AC Frequency	0.01 Hz	U16

Parameter Index	Parameters	Units	Data Type
15	Max – DC Link Voltage	0.1 V	U16
16	Max – DC Link Top	0.1 V	U16
17	Max – DC Link Bottom	0.1 V	U16
18	Max – DC Voltage	0.1V	U16
19	Max – DC Current	0.1 A	S16
20	Max – DC Current Phase A High Side	0.1 A	S16
21	Max – DC Current Phase B High Side	0.1 A	S16
22	Max – DC Current Phase C High Side	0.1 A	S16
23	Max – DC Current Phase A Low Side	0.1 A	S16
24	Max – DC Current Phase B Low Side	0.1 A	S16
25	Max – DC Current Phase C Low Side	0.1 A	S16
26	Max – 24V Bias	0.01 V	U16
27	Max – Temperature DC/DC Phase A	0.1 °C	S16
28	Max – Temperature DC/DC Phase B	0.1 °C	S16
29	Max – Temperature DC/DC Phase C	0.1 °C	S16
30	Max – Temperature Inverter Phase A	0.1 °C	S16
31	Max – Temperature Inverter Phase B	0.1 °C	S16
32	Max – Temperature Inverter Phase C	0.1 °C	S16
33	Max – Temperature Enclosure Air	0.1 °C	S16
34	Min – Real AC Power (P)	10 W	S16
35	Min – Reactive AC Power (Q)	10 VAR	S16
36	Min – AC Frequency	0.01 Hz	U16
37	Min – DC Current	0.1 A	S16
38	Min – DC Current Phase A High Side	0.1 A	S16
39	Min – DC Current Phase B High Side	0.1 A	S16
40	Min – DC Current Phase C High Side	0.1 A	S16
41	Min – DC Current Phase A Low Side	0.1 A	S16
42	Min – DC Current Phase B Low Side	0.1 A	S16
43	Min – DC Current Phase C Low Side	0.1 A	S16
44	Min – Temperature DC/DC Phase A	0.1 °C	S16
45	Min – Temperature DC/DC Phase B	0.1 °C	S16
46	Min – Temperature DC/DC Phase C	0.1 °C	S16
47	Min – Temperature Inverter Phase A	0.1 °C	S16
48	Min – Temperature Inverter Phase B	0.1 °C	S16
49	Min – Temperature Inverter Phase C	0.1 °C	S16
50	Min – Temperature Enclosure Air	0.1 °C	S16

The user may read a single parameter or up to a maximum of 64 parameters by using **REG 40458 – Operation Log – Read Min/Max Variables**. This is a 16-bit register in which the LSB is used to specify the index of the first parameter to be read, and the MSB specifies the # of

parameters to read. After writing to register 40458, the parameters can be read from the corresponding **Data Log Buffer Registers**.

For example, to read “Min – Temperature Exit Air”, write 0x0132 to register 40458 and then read register 40460.

To read the three consecutive parameters: “Min – Temp Inverter Phase A”, “Min – Temp Inverter Phase B”, and “Min – Temp Inverter Phase C”, write 0x032F to register 40458 and then read registers 40460 to 40462. The read buffer will be organized as follows:

Data Log Buffer Address	Parameter
40460	Min – Temperature Inverter Phase A
40461	Min – Temperature Inverter Phase B
40462	Min – Temperature Inverter Phase C

10. Communications Interface

The power supply is equipped with a Modbus RS485 communications interface. Modbus is an application layer messaging protocol that provides client/server communication between devices connected on different types of buses or networks.

Table 20 - Modbus Interface Specifications

Interface	RS-485
Data Transfer Method	Half duplex
Data Transfer Speed	User Configurable
Protocol	Modbus RTU over Serial Interface
Connector	D-Sub 15
Cable Type	Twisted Pair
Default Slave Address	1, User Configurable
Response Time	Time from receipt of message to beginning of reply: <ul style="list-style-type: none"> • 2.5ms max - Command/Instrumentation Registers • 8ms max - Configuration Registers

10.1 Modbus Overview

Modbus is a request/reply protocol and offers services specified by *function codes*, which are elements of Modbus request/reply protocol data units (PDUs). The MODBUS application protocol specifies that all requests are initiated by a client. The function code field indicates to the server what kind of action to perform and is coded in one byte. Valid codes are in the range of 1 ... 255 decimal (the range 128 – 255 is reserved and used for exception responses). When a message is sent from a Client to a Server device the function code field tells the server what

kind of action to perform. Function code "0" is not valid. Sub-function codes are added to some function codes to define multiple actions. The data field of messages sent from a client to server devices contains additional information that the server uses to take the action defined by the function code. This can include items like discrete and register addresses, the quantity of items to be handled, and the count of actual data bytes in the field. The data field may be nonexistent (of zero length) in certain kinds of requests, in this case the server does not require any additional information. The function code alone specifies the action.

If no error occurs related to the Modbus function requested in a properly received Modbus PDU, the data field of a response from a server to a client contains the data requested. If an error related to the Modbus function requested occurs, the field contains an exception code that the server application can use to determine the next action to be taken. For example, a client can read the ON / OFF states of a group of discrete outputs or inputs or it can read/write the data contents of a group of registers. When the server responds to the client, it uses the function code field to indicate either a normal (error-free) response or that an error occurred (called an exception response). For a normal response, the server simply echoes to the request the original function code.

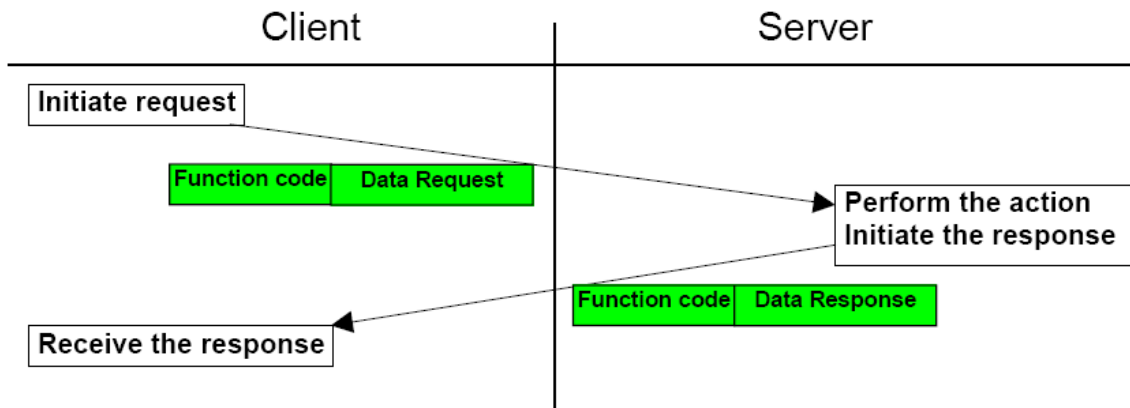

For an exception response, the server returns a code that is equivalent function code from the request PDU with its most significant bit set to logic 1.

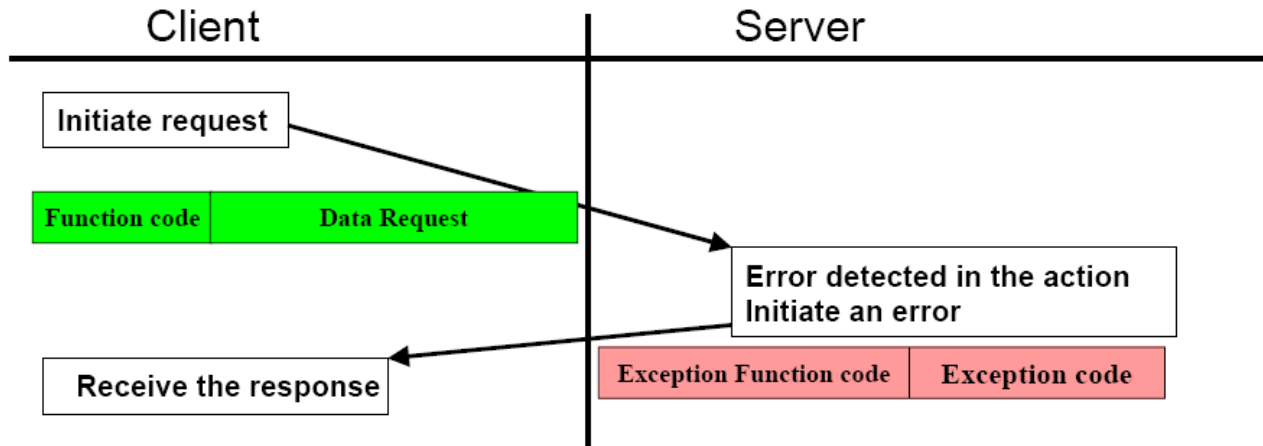

10.2 Physical Layer

The RS-485 physical interface conforms to the Modbus specification published on the Modbus.org site in 2002 (Modbus_over_serial_line_V1.pdf, Nov 2002).

10.3 RTU Transmission Mode

Modbus supports two modes of transmission, ASCII (American Standard Code for Information Interchange), and RTU (Remote Terminal Unit). The supply uses the more efficient RTU transmission mode. The Modbus specification defines the message frame or Serial Line PDU “Protocol Data Unit” as shown in Figure 22.

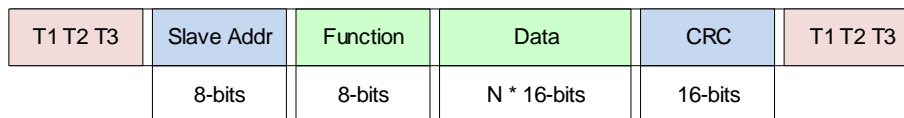

Figure 22 - RTU Message Frame (PDU) Format

10.3.1 Synchronization

The Modbus specification for synchronization is as follows: Frame synchronization is established by limiting the elapsed time between receipt of characters. The T1, T2, T3 items at the beginning and end of the frame depict approximately three character times of idle time. If three character times elapse without a new character or completion of a frame, then the pending message will be flushed, and the next byte received will be treated as the address field of the message frame.

10.3.2 Slave Address

The 8-bit slave address field defines the unique ID (1-247) of the slave device that is to receive the message sent by the master. When the slave sends a response, the address field informs the master which slave is communicating.

The PCS supports Slave Address 0, which is used for Modbus *Broadcast Mode*. In *Broadcast Mode*, the Modbus Master can send a message to **all** slaves on the network at the same time. In this mode, slaves do not reply to the Modbus Master. Using *Broadcast Mode* is useful when operating multiple PCS units in parallel and the user wants them all to respond to the same register commands simultaneously, such as when turning on or off or changing operating setpoints.

10.3.3 Function Code

The 8-bit function code tells the addressed slave what function to perform. If the slave is able to perform the requested function, the function code in the response will be that of the request. The slave will set the high order bit of the function code to one in the response to indicate an exception.

10.3.4 Data Field

The data field will vary in length according to which function is specified. This field contains information required by the slave to perform the specific function or it contains data collected by the slave in response to a query.

Modbus uses a 'Big-Endian' representation for addresses and data items. This means that when a numerical quantity larger than a single byte is transmitted, the most significant byte is sent first. For example, a 16-bit register size value of 0x1234 would be transmitted with the first byte sent being 0x12 then 0x34.

10.3.5 CRC Error Check

The two-byte error check field allows the master and slave devices to check messages for transmission errors. A Cyclic Redundancy Check (CRC) is performed by the master and the slave devices. The error checking assures that the master or slave does not react to messages that have changed during transmission.

The CRC-16 polynomial is used to compute the checksum for the message content. The formula for the CRC-16 polynomial is:

$$x^{16} + x^{15} + x^2 + 1$$

The checksum can be computed using the following algorithm:

1. Load a 16-bit register with all 1's.
2. Exclusive OR the first 8-bit byte of the message with the high order byte of the 16-bit register, putting the result in the 16-bit register.
3. Shift the 16-bit register 1 bit to the right.
4. If the bit shifted out to the right is a 1, exclusive OR the generating polynomial (1010 0000 0000 0001) with the 16-bit register. If the bit is a 0, do not modify the register.
5. Repeat steps 3 & 4 until 8 shifts have been performed.
6. Exclusive OR the next 8-bit byte of the message with the 16-bit register.
7. Repeat steps 3 through 6 until all bytes of the message have been exclusive OR'd with the 16-bit register and shifted eight times.
8. The final content of the register is the CRC value

When the 16-bit CRC value is transmitted in the message, the low-order byte must be transmitted first, followed by the high-order byte.

10.3.6 Exception Response

There are two possible exception modes the supply must handle:

- The supply (slave) receives the request, but detects a communication error (parity, LRC, CRC, ...), no response is returned. The host will eventually process a timeout condition for the request.
- The supply (slave) receives the request without a communication error, but cannot handle it (for example, if the request is to read a non-existent output or register), the supply will return an exception response informing the host of the nature of the error.

When the supply detects an error, it sends a response message to the host consisting of the function code (with high order bit set to one) and an error code (8-bits). The exception error codes are as follows:

Table 21 - Modbus Exception Codes

Code	Name	Meaning
01	Illegal Function	The message function is not supported by the PCS.
02	Illegal Data Address	The address (in the write request) or start address (in the read request) referenced in the data field is not valid.
03	Illegal Data Value	The value or count specified in the data field is not allowable.

10.4 Function Code Descriptions

The supply provides a subset of the available Modbus functions, namely functions 3 (Read Holding Registers), 6 (Preset Single Register), and 16 (Write Multiple Registers).

10.4.1 Read Holding Registers (Function Code 03)

This function code is used to read the contents of a contiguous block of registers. The request PDU specifies the starting register address and the number of registers. In the PDU registers are addressed starting at zero. Therefore, registers numbered 1-16 are addressed as 0-15.

The response includes the slave address, function code, length of response values in bytes, the response values, and error check. The data consists of two bytes for each register, with the binary content right justified within each pair. The first byte includes the high order bits and the second, the low order bits.

Request PDU:

Slave Addr	Func Code	Starting Address	# of Registers	CRC
8-bits	8-bits	16-bits	16-bits	16-bits

Response PDU:

Slave Addr	Func Code	Data Length	Data ... Data		CRC
8-bits	8-bits	8-bits	16-bits	16-bits	16-bits

Error PDU:

Slave Addr	Error Code	Exception Code	CRC
8-bits	0x83	8-bits	16-bits

Here is an example request to read **REG 40088-40090 - Current – Phase A/B/C**, from slave 10

Request		Response	
Field Name	(Hex)	Field Name	(Hex)
Slave Address	0A	Slave Address	0A
Function	03	Function	03
Starting Address Hi	9C	Byte Count	06
Starting Address Lo	97	Reg Value Hi (40088)	02
# of Registers Hi	00	Reg Value Lo (40088)	14
# of Registers Lo	03	Reg Value Hi (40089)	00
CRC Lo	crc_l	Reg Value Lo (40089)	12
CRC Hi	crc_h	Reg Value Hi (40090)	00
		Reg Value Lo (40090)	15
		CRC Lo	crc_l
		CRC Hi	crc_h

10.4.2 Preset Single Command Register (Function Code 06)

This function code is used to write a single holding register. The request PDU specifies the address of the register to be written. Registers are addressed starting at zero. Therefore, register numbered 1 is addressed as 0. The normal response is an echo of the request, returned after the register contents have been written.

Request PDU:

Slave Addr	Func Code	Register Address	Register Value	CRC
8-bits	8-bits	16-bits	16-bits	16-bits

Response PDU:

Slave Addr	Func Code	Register Address	Register Value	CRC
8-bits	8-bits	16-bits	16-bits	16-bits

Error PDU:

Slave Addr	Error Code	Exception Code	CRC
8-bits	0x86	8-bits	16-bits

Here is an example request to write **REG 40143 – PCS Set Operation** with a value of 1 (connect) on Slave 10:

Request		Response	
Field Name	(Hex)	Field Name	(Hex)
Slave Address	0A	Slave Address	0A
Function	06	Function	06
Register Address Hi	9C	Register Address Hi	9C
Register Address Lo	CE	Register Address Lo	CE
Register Value Hi	00	Register Value Hi	00
Register Value Lo	01	Register Value Lo	01
CRC Lo	crc_l	CRC Lo	crc_l
CRC Hi	crc_h	CRC Hi	crc_h

10.4.3 Write Multiple Registers (Function Code 16)

This function code is used to write a block of contiguous registers (1 to 123 registers). The requested written values are specified in the request data field. Data is packed as two bytes per register. The normal response returns the function code, starting address, and quantity of registers written.

Request PDU:

Slave Addr	Func Code	Starting Address	# of Registers	Byte Count	Register Values	CRC
8-bits	8-bits	16-bits	16-bits	8-bits	16-bits x n	16-bits

n = # of registers

Response PDU:

Slave Addr	Func Code	Starting Address	# of Registers	CRC
8-bits	8-bits	16-bits	16-bits	16-bits

Error PDU:

Slave Addr	Error Code	Exception Code	CRC
8-bits	0x90	8-bits	16-bits

Here is an example request to write 2 registers on Slave 10, **REG 40191/40192 – AC Over Current Fault/Warning Threshold**, to a value of 540 (54 A_{RMS}) and 520 (52 A_{RMS}):

Request		Response	
Field Name	(Hex)	Field Name	(Hex)
Slave Address	0A	Slave Address	0A
Function	10	Function	10
Starting Address Hi	9C	Starting Address Hi	9C
Starting Address Lo	FE	Starting Address Lo	FE
# of Registers Hi	00	# of Registers Hi	00
# of Registers Lo	02	# of Registers Lo	02
Byte Count	04	CRC Lo	crc_l
Register Value Hi	02	CRC Hi	crc_h
Register Value Lo	1C		
Register Value Hi	02		
Register value Lo	08		
CRC Lo	crc_l		
CRC Hi	crc_h		

11. MESA-PCS Modbus Profile

The MESA-PCS Modbus profile from the Modular Energy Storage Architecture (MESA) Alliance defines a comprehensive set of measured values and parameters as a standard interface for power conversion components in an energy storage system.

All MESA-compliant power conversion systems are, by definition, SunSpec devices. This means that they must include the Common Model at the top of their Modbus register map, and they must include the End Model at the end of their register map. Additionally, all MESA-compliant power conversion systems must implement a small number of SunSpec inverter models. The supply implements the following Models

Table 22 - SunSpec/MESA Models

Model ID	Description
1	Common Model
17	Serial Interface
103	3-Phase Inverter Model (Integer based)
64800	MESA - PCS Extension
64050	Oztek - PCS Control and Status
64052	Oztek - PCS Alarm Settings
64053	Oztek - PCS Grid Monitor Settings
64054	Oztek - PCS Firmware Update
64055	Oztek - PCS Datalogging
0xFFFF	End Model

11.1 Register Properties

11.1.1 Register Number

The register *Number* listed in the tables below represents the Modbus identifier for each parameter. It is important to note that these register *numbers* are 1-based, meaning they start counting from 1. This differs from the physical *address* that is transmitted across the bus when accessing these registers. The physical *addresses* are 0-based, meaning they start counting from 0.

Note: *Offset of Modbus Register Numbers*

To read or write Modbus registers the “Address” is 1 less than the register number. Example: Address of Register 40001 is $40001 - 1 = 40000$.

11.1.2 Access Level

The access level for each register is defined as follows:

W = Writeable – the parameter is writable by the user

R = Readable – the parameter is readable by the user

O = Operating – the parameter may *NOT* be written while the supply is ON, writes to any parameter with this indicator will be ignored if the supply is ON

C = Cyclical – the writeable parameter may be cyclically updated with no risk of damage



CAUTION

Write (W) parameters must not be changed cyclically.

The majority of registers that can be modified using Modbus Write commands (W) are non-volatile and intended for long term storage of device configuration. Cyclical changing of these parameters will lead to failure of the non-volatile memory device.

Registers used for the immediate control and limitation are an exception and may be changed cyclically with no damage to the electronics. These registers are denoted with a cyclical (C) access designator.

11.1.3 SunSpec Data Formats

- **int**: signed integer value.
- **uint**: unsigned integer value
- **pad**: reserved field, used to round a Model to an even number of registers
- **acc**: accumulated value, used for ever increasing values that may rollover
- **enum**: enumerated value, used for status and state
- **bitfield**: a collection of bits, multi-valued alarms or state
- **string**: a null terminated or fixed length value
- **sunssf**: defines value to shift decimal point to left (negative) or right (positive)

11.1.4 SunSpec Data Type U16

U16 represents all unsigned, 16-bit integer values and consist of a single register. Values are stored in big-endian order.

Modbus Register	1															
Byte	0								1							
Bits	15	14	13	12	10	11	9	8	7	6	5	4	3	2	1	0

U16 Format	Range	Not Implemented Value
Integer	0 ... 65534	0xFFFF
Acc16	0 ... 65534	0x0000
ENUM	0 ... 65534	0xFFFF
Bitfield	0 ... 0x7FFF	0xFFFF
Pad	0x8000	Always returns 0x8000

11.1.5 SunSpec Data Type S16

S16 represents all signed, 16-bit integer values and consist of a single register. Values are stored in big-endian order.

Modbus Register	1															
Byte	0								1							
Bits	15	14	13	12	10	11	9	8	7	6	5	4	3	2	1	0

S16 Format	Range	Not Implemented Value
Integer	-32767 ... 32767	0x8000
Sunssf	-10 ... 10	0x8000

11.1.6 SunSpec Data Type U32

U32 represents all unsigned, 32-bit integer values and consist of two registers in big-endian order.

Modbus Register	1				2											
Byte	0		1		2		3									
Bits	31 ... 24				23 ... 16				15 ... 8				7 ... 0			

U32 Format	Range	Not Implemented Value
Integer	0 ... 4,292,967,294	0xFFFF FFFF
Acc32	1 ... 4,292,967,295	0x0000 0000
ENUM	0 ... 4,292,967,294	0xFFFF FFFF
Bitfield	0 ... 0x7FFF FFFF	0xFFFF FFFF

11.1.7 SunSpec Data Type S32

S32 represents all unsigned, 32-bit integer values and consist of two registers in big-endian order.

Modbus Register	1				2											
Byte	0		1		2		3									
Bits	31 ... 24				23 ... 16				15 ... 8				7 ... 0			

S32 Format	Range	Not Implemented Value
Integer	-2,147,483,647 2,147,483,647	0x8000 0000

11.1.8 SunSpec Data Type U64

U64 represents all unsigned, 64-bit integer values and consist of four registers in big-endian order.

Modbus Register	1			2		
Byte	0	1	2	3		
Bits	63 ... 56	55 ... 48	47 ... 40	39 ... 32		

Modbus Register	3			4		
Byte	4	5	6	7		
Bits	31 ... 24	23 ... 16	15 ... 8	7 ... 0		

U32 Format	Range	Not Implemented Value
Integer	0 ... 9,223,372,036,854,775,806	0xFFFF FFFF FFFF FFFF
Acc32	1 ... 9,223,372,036,854,775,807	0x0000 0000 0000 0000
ENUM	0 ... 9,223,372,036,854,775,806	0xFFFF FFFF FFFF FFFF
Bitfield	0 0x7FFF FFFF FFFF FFFF	0xFFFF FFFF FFFF FFFF

11.1.9 SunSpec Data Type String

String represents a variable length string value in a fixed size register range using a NULL (0 value) to terminate or pad the string. For example, up to 16 characters can be stored in 8 contiguous registers as follows:

Modbus Register	1		2		3		4		5		6		7		8	
Byte	0	1	2	3	4	5	6	7	8	9	10	11	12	13	14	15
Character	E	X	A	M	P	L	E	spc	S	T	R	I	N	G	!	NULL

Not Implemented Value: all registers filled with NULL or 0x0000.

11.2 Register Models

The following sections tabulate the registers for each of the SunSpec and Oztek Extension models. The tables only include the implemented registers, Modbus reads of unimplemented registers will return the “Not Implemented” values defined in sections 11.1.4 through 11.1.9.

11.2.1 SunSpec Model 1 Registers – Common Model

Number	Data Type	Description	Units	Scale Factor (Reg #)	Factory Default	Min	Max	Access Level
Header:								
40001	U32	SunSpec ID - Allows discovery as a SunSpec compatible device.	n/a	n/a	0x53756E53	n/a	n/a	R
40003	U16	Model Identifier	n/a	n/a	1	n/a	n/a	R
40004	U16	Model Length - # of 16-bit registers to follow	n/a	n/a	66	n/a	n/a	R
Fixed Block:								
40005-40020	Str	Manufacturer	ASCII	n/a	"Oztek Corp."	n/a	n/a	R
40021-40036	Str	Model	ASCII	n/a	"OZpcs-RS40-PS"	n/a	n/a	R
40045-40052	Str	Version: Byte 10..0: Firmware Revision Byte 11..12: Release Code: '-R' – Production Release '-C' – Release Candidate '-E' – Experimental Debug Build	ASCII	n/a	n/a	n/a	n/a	R
40053-40068	Str	Serial number	ASCII	n/a	n/a	n/a	n/a	R
40069	U16	Modbus Device Address	n/a	n/a	1	1	247	RWO ¹

¹ New value will not take effect until next POR

11.2.2 SunSpec Model 17 Registers – Serial Interface

Number	Data Type	Description	Units	Scale Factor (Reg #)	Factory Default	Min	Max	Access Level
Header:								
40071	U16	Model Identifier	n/a	n/a	17	n/a	n/a	R
40072	U16	Model Length - # of 16-bit registers to follow	n/a	n/a	12	n/a	n/a	R
Fixed Block:								
40077	U32	Baud Rate: Supported values = 4800, 19200, 38400, 57600, and 115200 (all others result in default of 57600)	bps	n/a	57600	4800	115200	RWO ¹
40079	U16	Bits Per Character	n/a	n/a	8	n/a	n/a	R
40080	U16	Parity: 0 = None; 1 = Odd; 2 = Even	ENUM	n/a	0	0	2	RWO ¹
40081	U16	Duplex: 0 = Full; 1 = Half	ENUM	n/a	1	n/a	n/a	R
40082	U16	Flow Control: 0 = None; 1 = Hardware flow control; 2 = Software (XON/XOFF) flow control	ENUM	n/a	0	n/a	n/a	R
40083	U16	Interface type: 0 = Unknown; 1 = RS232; 2 = RS485	ENUM	n/a	2	n/a	n/a	R
40084	U16	Protocol: 0 = Unknown; 1 = Modbus; 2 = Vendor Specific	ENUM	n/a	1	n/a	n/a	R

¹ New value will not take effect until next POR

² The number of **STOP BITS** (not included in model) is fixed at '1'

11.2.3 SunSpec Model 103 Registers – Three Phase Inverter (Fixed Point)

Number	Data Type	Description	Units ¹	Scale Factor (Reg #)	Factory Default	Min	Max	Access Level
Header:								
40085	U16	Model Identifier	n/a	n/a	103	n/a	n/a	R
40086	U16	Model Length - # of 16-bit registers to follow	n/a	n/a	50	n/a	n/a	R
Fixed Block:								
40087	U16	AC Current (sum of all phases)	0.1 A _{rms}	40091	n/a	n/a	n/a	R
40088	U16	Current – Phase A	0.1 A _{rms}	40091	n/a	n/a	n/a	R
40089	U16	Current – Phase B	0.1 A _{rms}	40091	n/a	n/a	n/a	R

Number	Data Type	Description	Units ¹	Scale Factor (Reg #)	Factory Default	Min	Max	Access Level
40090	U16	Current – Phase C	0.1 A _{rms}	40091	n/a	n/a	n/a	R
40091	S16	Scale Factor – Current	Sunssf	n/a	-1	n/a	n/a	R
40092	U16	Phase Voltage – AB	0.1 V _{rms}	40098	n/a	n/a	n/a	R
40093	U16	Phase Voltage – BC	0.1 V _{rms}	40098	n/a	n/a	n/a	R
40094	U16	Phase Voltage – CA	0.1 V _{rms}	40098	n/a	n/a	n/a	R
40095	U16	Phase Voltage – AN	0.1 V _{rms}	40098	n/a	n/a	n/a	R
40096	U16	Phase Voltage – BN	0.1 V _{rms}	40098	n/a	n/a	n/a	R
40097	U16	Phase Voltage – CN	0.1 V _{rms}	40098	n/a	n/a	n/a	R
40098	U16	Scale Factor – AC Voltage	Sunssf	n/a	-1	n/a	n/a	R
40099	S16	AC Power	10 W	40100	n/a	n/a	n/a	R
40100	S16	Scale Factor – AC Power	Sunssf	n/a	1	n/a	n/a	R
40101	U16	Line Frequency	0.01 Hz	40102	n/a	n/a	n/a	R
40102	S16	Scale Factor – Line Frequency	Sunssf	n/a	-2	n/a	n/a	R
40103	S16	AC Apparent Power	10 VA	40104	n/a	n/a	n/a	R
40104	S16	Scale Factor – AC Apparent Power	Sunssf	n/a	1	n/a	n/a	R
40105	S16	AC Reactive Power	10 VAr	40106	n/a	n/a	n/a	R
40106	S16	Scale Factor – AC Reactive Power	Sunssf	n/a	1	n/a	n/a	R
40107	S16	Power Factor	n/a	40108	n/a	n/a	n/a	R
40108	S16	Scale Factor – Power Factor	Sunssf	n/a	-3	n/a	n/a	R
40112	S16	DC Current	0.1 A	40113	n/a	n/a	n/a	R
40113	S16	Scale Factor – DC Current	Sunssf	n/a	-1	n/a	n/a	R
40114	S16	DC Voltage – voltage measured at the DC terminals	0.1 V	40115	n/a	n/a	n/a	R
40115	S16	Scale Factor – DC Voltage	Sunssf	n/a	-1	n/a	n/a	R
40116	S16	DC Power	10 W	40117	n/a	n/a	n/a	R
40117	S16	Scale Factor – DC Power	Sunssf	n/a	1	n/a	n/a	R
40118	S16	Cabinet Temperature	C	40122	n/a	n/a	n/a	R
40119	S16	Heatsink Temperature Inverter (Hottest of all measured)	C	40122	n/a	n/a	n/a	R
40121	S16	Heatsink Temperature DC/DC (Hottest of all measured)	C	40122	n/a	n/a	n/a	R
40122	S16	Scale Factor – Temperature	sunssf	n/a	0	n/a	n/a	R

Number	Data Type	Description	Units ¹	Scale Factor (Reg #)	Factory Default	Min	Max	Access Level
40129	U32	<p>Vendor Bitfield 1 – Fault Status:</p> <p>Bit 0 = H/W Over Current A Bit 1 = H/W Over Current B Bit 2 = H/W Over Current C Bit 3 = S/W Over Current A Bit 4 = S/W Over Current B Bit 5 = S/W Over Current C Bit 6 = S/W DC Over Current Bit 7 = Grid AB Over Voltage Bit 8 = Grid BC Over Voltage Bit 9 = Grid CA Over Voltage Bit 10 = H/W DC Over Voltage Bit 11 = S/W DC Over Voltage</p> <p>Bits 12-17 = reserved Bit 18 = PLL Loss of Lock Bit 19 = Over Temperature Bit 20 = ESTOP Bit 21 = Communication Error Bit 22 = Power Down Error Bit 23 = Invalid User Config Bit 24 = Invalid Model Bit 25 = Factory Fault Bit 26 = reserved Bit 27 = Max Offline Retries Bit 28 = Offline Timeout</p>	Bitfield	n/a	n/a	n/a	n/a	R
40131	U32	<p>Vendor Bitfield 2 – Warning Status:</p> <p>Bit 0 = High Current A Bit 1 = High Current B Bit 2 = High Current C Bit 3 = High DC Current Bit 4 = High Grid Voltage AB Bit 5 = High Grid Voltage BC Bit 6 = High Grid Voltage CA Bit 7 = High DC Voltage Bits 8-11 = reserved Bit 12 = DC Current Limit Bit 13 = DC Power Limit Bit 14 = reserved Bit 15 = PLL Not Locked</p> <p>Bit 16 = High DC/DC Temp Bit 17 = High Inverter Temp Bit 18 = High Ambient Temp Bit 19 = Fan 1 Error Bit 20 = Fan 2 Error Bit 21 = Fan 3 Error Bit 22 = AC Line Freq OOT Bit 23 = AC Line V-AB OOT Bit 24 = AC Line V-BC OOT Bit 25 = AC Line V-CA OOT Bit 26 = Offline Retry Delay Bits 27-29 = reserved Bit 30 = TVS Error</p>	Bitfield	n/a	n/a	n/a	n/a	R

Number	Data Type	Description	Units ¹	Scale Factor (Reg #)	Factory Default	Min	Max	Access Level
40133	U32	Vendor Bitfield 3 – Factory Fault Status: Bit 0 = H/W DC Over Current A - bot Bit 1 = H/W DC Over Current B - bot Bit 2 = H/W DC Over Current C - bot Bit 3 = H/W DC Over Current A - top Bit 4 = H/W DC Over Current B - top Bit 5 = H/W DC Over Current C - top Bit 6 = DC Over Current A Bit 7 = DC Over Current B Bit 8 = DC Over Current C Bit 9 = DC Current Imbalance A Bit 10 = DC Current Imbalance B Bit 11 = DC Current Imbalance C Bit 12 = H/W DC Link Over Voltage - top Bit 13 = H/W DC Link Over Voltage - bot Bit 14 = DC Link Over Voltage Bit 15 = DC Link Voltage Imbalance Bit 16 = Pre-charge Timeout Bit 17 = Bias Under Voltage Bit 18 = <i>Reserved</i> Bit 19 = DC/DC Communication Error Bit 20 = Datalog Error Bit 21 = Invalid Factory Configuration Bit 22 = Configuration EEPROM Error Bit 23 = Calibration Error Bits 24-31 = <i>Reserved</i>	Bitfield	n/a	n/a	n/a	n/a	R

¹ Units include applied scale factor register

11.2.4 SunSpec Model 64800 Registers – MESA PCS Extension

Number	Data Type	Description	Units	Scale Factor (Reg #)	Factory Default	Min	Max	Access Level
Header:								
40137	U16	Model Identifier	n/a	n/a	64800	n/a	n/a	R
40138	U16	Model Length - # of 16-bit registers to follow	n/a	n/a	8	n/a	n/a	R
Fixed Block:								
40139	U16	Local/Remote Control: 0 = Remote; 1 = Local (HMI)	ENUM	n/a	0	n/a	n/a	R
40140	U16	Power Supply Heartbeat – Value is incremented every sec with periodic resets to zero.	n/a	n/a	0	n/a	n/a	R
40141	U16	Host Heartbeat The supply expects this register to be incremented by the Host every second with periodic resets to zero. Failure to do so will result in a fault condition. The timeout isn't armed until the first write to this register following a POR.	n/a	n/a	0	0	0xFFFF	RWC

Number	Data Type	Description	Units	Scale Factor (Reg #)	Factory Default	Min	Max	Access Level
40142	U16	Fault Reset: 0 = No Action; 1 = Reset Faults This register is auto cleared to zero after a write.	ENUM	n/a	0	0	1	RWC
40143	U16	Set Operation 1 = Connect (pre-charge and connect AC contactor) 2 = Disconnect (disconnect AC contactor) 3 = Standby Mode (stop processing power) 4 = Run Mode (start processing power) This register is auto cleared to zero after a write.	ENUM	n/a	0	0	4	RWC

11.2.5 Oztek Extension Model 64050 Registers – Control and Status

Number	Data Type	Description	Units	Scale Factor (Reg #)	Factory Default	Min	Max	Access Level
Header:								
40147	U16	Model Identifier	n/a	n/a	64050	n/a	n/a	R
40148	U16	Model Length - # of 16-bit registers to follow	n/a	n/a	40	n/a	n/a	R
Fixed Block:								
40149	U16	PCS Control Mode: 0 = DC Voltage Control 1 = DC Current Control 2 = DC Power Control	ENUM	n/a	0	0	2	RWO
40150	U16	Maximum AC Power – Continuous AC Power Rating	10 W	n/a	4000	n/a	n/a	R
40151	U16	DC Voltage Setpoint ⁰	0.1 V	n/a	0	REG 40153	REG 40152	RWC
40152	U16	DC Voltage Setpoint Maximum ⁰	0.1 V	n/a	8200	0	8200	RW
40153	U16	DC Voltage Setpoint Minimum ⁰	0.1 V	n/a	0	0	8200	RW
40154	U16	DC Voltage Setpoint Power-On Default ⁰	0.1 V	n/a	6000	0	8200	RW
40155	U16	DC Voltage Slew Rate ⁰	0.1 V/s	n/a	10000	1	20000	RW
40156	U16	DC Voltage Droop Control Resistance ⁰ – to disable voltage droop control (i.e., for single unit operation), set this register to zero.	mOhm	n/a	250	0	5000	RW
40157	S16	DC Current Setpoint ¹	0.1 A	n/a	0	REG 40159	REG 40158	RWC

Number	Data Type	Description	Units	Scale Factor (Reg #)	Factory Default	Min	Max	Access Level
40158	S16	DC Current Maximum – current is limited to this value for all modes	0.1 A	n/a	750	-750	750	RW
40159	S16	DC Current Minimum – current is limited to this value for all modes	0.1 A	n/a	-750	-750	750	RW
40160	S16	DC Current Setpoint Power-On Default ¹	0.1 A	n/a	0	-750	750	RW
40161	U16	DC Current Slew Rate – max rate enforced for DC Current or Power mode	0.1 A/s	n/a	750	1	3000	RW
40162	S16	DC Power Setpoint ²	10 W	n/a	0	REG 40164	REG 40163	RWC
40163	S16	DC Power Maximum – power is limited to this value for all modes	10 W	n/a	3850	-3850	3850	RW
40164	S16	DC Power Minimum – power is limited to this value for all modes	10 W	n/a	-3850	-3850	3850	RW
40165	S16	DC Power Setpoint Power-On Default ²	10 W	n/a	0	-3850	3850	RW
40166	U16	DC Power Slew Rate ²	10 W/s	n/a	3850	1	11550	RW
40167	U16	Operating State 0 = Init 5 = Charging 1 = Fault 6 = Standby 2 = Calibration 7 = On 3 = Disabled 8 = Off-Line 4 = Charge Wait 9 = Power Down	ENUM	n/a	n/a	n/a	n/a	R
40168	U16	Register Operation Status - Updated after every parameter read or write. 0 = Operation completed successfully 1 = Illegal/unsupported Parameter ID 2 = write was attempted to a Read-Only Parameter 3 = read was attempted from a Write-Only Parameter 4 = write data is not within legal range 5 = Configuration Memory Hardware Error 6 = Configuration Memory CRC Mismatch 7 = Invalid password provided for operation 8 = Operation not allowed when the inverter is ON	ENUM	n/a	n/a	n/a	n/a	R
40169	U16	User Configuration Error Status Bits Bit 0 = Invalid Baud Rate	ENUM	n/a	n/a	n/a	n/a	R
40170	U16	Factory Temperature Error Status: Bit 0 = Ambient Over Temp Bit 8 = Inverter Over Temp - A Bit 1 = DC/DC Over Temp - A Bit 9 = Inverter Over Temp - B Bit 2 = DC/DC Over Temp - B Bit 10 = Inverter Over Temp - C Bit 3 = DC/DC Over Temp - C Bit 11 = Inverter Temp Imbalance Bit 4 = DC/DC Temp Imbalance Bits 12-15 = <i>Reserved</i>	ENUM	n/a	n/a	n/a	n/a	R

Number	Data Type	Description	Units	Scale Factor (Reg #)	Factory Default	Min	Max	Access Level
40171	U16	Software Revision – Inverter Controller	n/a	n/a	n/a	n/a	n/a	R
40172	U16	Software Revision – DC/DC Controller	n/a	n/a	n/a	n/a	n/a	R
40173	U16	Software Revision – Bootloader	n/a	n/a	n/a	n/a	n/a	R
40174	U16	FPGA Revision	n/a	n/a	n/a	n/a	n/a	R
40175	U16	User Configuration Revision The user may use this register to assign a revision code, allowing them to manage their changes to the default product configuration.	n/a	n/a	0	0	0xFFFF	RW
40176	U16	Factory Configuration Revision	n/a	n/a	n/a	n/a	n/a	R
40177	U16	Master Configuration Revision	n/a	n/a	n/a	n/a	n/a	R
40178	U16	Configuration Reset – Write a ‘0’ to set User Values to Factory Defaults	n/a	n/a	0	0	0xFFFF	RW

⁰ Register only used when operating in DC Voltage Control Mode (REG 40149 – PCS Control Mode = 0)

¹ Register only used when operating in DC Current Control Mode (REG 40149 – PCS Control Mode = 1)

² Register only used when operating in DC Power Control Mode (REG 40149 – PCS Control Mode = 2)

11.2.6 Oztek Extension Model 64052 Registers – Alarms

Number	Data Type	Description	Units ¹	Scale Factor (Reg #)	Factory Default	Min	Max	Access Level
Header:								
40189	U16	Model Identifier	n/a	n/a	64052	n/a	n/a	R
40190	U16	Model Length - # of 16-bit registers to follow	n/a	n/a	46	n/a	n/a	R
Fixed Block:								
40191	U16	AC Over Current Fault Threshold	0.1 Arms	40226	540	0	540	RW
40192	U16	AC Over Current Warning Threshold	0.1 Arms	40226	520	0	540	RW
40193	U16	AC Over Current Warning Recover Delta	0.1 Arms	40226	25	10	100	RW
40194	U16	AC Over Voltage Fault Threshold (line to line)	0.1 Vrms	40225	5850	0	5850	RW
40195	U16	AC Over Voltage Warning Threshold (line to line)	0.1 Vrms	40225	5750	0	5850	RW
40196	U16	AC Over Voltage Warning Recover Delta (line to line)	0.1 Vrms	40225	50	10	1000	RW
40197	U16	DC Over Voltage Fault Threshold	0.1 V	40227	8400	0	8400	RW
40198	U16	DC Over Voltage Warning Threshold	0.1 V	40227	8300	0	8400	RW

Number	Data Type	Description	Units ¹	Scale Factor (Reg #)	Factory Default	Min	Max	Access Level
40199	U16	DC Over Voltage Warning Recover Delta	0.1 V	40227	50	10	1000	RW
40200	U32	Alarm Output 1 - Supply Fault Mask The bit fields correspond to Register 40129 – Fault Status . Setting a mask bitfield to “1” will cause that fault to drive the Alarm output. Setting multiple mask bits to “1” logically OR’s them together.	ENUM	n/a	0xFFFF FFFF	0	0xFFFF FFFF	RW
40202	U32	Alarm Output 1 - Supply Warning Mask The bit fields correspond to Register 40131 – Warning Status . Setting a mask bitfield to “1” will cause that warning to drive the Alarm output. Setting multiple mask bits to “1” logically OR’s them together.	ENUM	n/a	0	0	0xFFFF FFFF	RW
40204	U32	Alarm Output 2 - Supply Fault Mask The bit fields correspond to Register 40129 – Fault Status . Setting a mask bitfield to “1” will cause that fault to drive the Alarm output. Setting multiple mask bits to “1” logically OR’s them together.	ENUM	n/a	0	0	0xFFFF FFFF	RW
40206	U32	Alarm Output 2 - Supply Warning Mask The bit fields correspond to Register 40131 – Warning Status . Setting a mask bitfield to “1” will cause that warning to drive the Alarm output. Setting multiple mask bits to “1” logically OR’s them together.	ENUM	n/a	0xFFFF FFFF	0	0xFFFF FFFF	RW
40208	U16	Alarm Output Pin Polarity Bit 0: Alarm Output 1 Polarity Value 0 = High-Z when status is True Value 1 = Drive output low when status is True Bit 1: Alarm output 2 Polarity Value 0 = High-Z when status is True Value 1 = Drive output low when status is True	ENUM	n/a	0	0	3	RW
40225	S16	Scale Factor – AC Voltage	sunssf	n/a	-1	n/a	n/a	R
40226	S16	Scale Factor – AC Current	sunssf	n/a	-1	n/a	n/a	R
40227	S16	Scale Factor – DC Voltage	sunssf	n/a	-1	n/a	n/a	R

¹ Units include applied scale factor register

11.2.7 Oztek Extension Model 64053 Registers – Grid Monitor Settings

Number	Data Type	Description	Units	Scale Factor (Reg #)	Factory Default	Min	Max	Access Level
Header:								
40237	U16	Model Identifier	n/a	n/a	64053	n/a	n/a	R
40238	U16	Model Length - # of 16-bit registers to follow	n/a	n/a	22	n/a	n/a	R
Fixed Block:								
40239	U16	Nominal AC Input Voltage	0.1 Vrms	n/a	4800	3000	4800	RWO
40240	U16	Nominal AC Input Frequency	0.01 Hz	n/a	6000	4500	6500	RWO
40241	U16	Grid High Voltage Trip Threshold (% of Reg 40239)	0.1 %	n/a	1080	1000	1200	RWO
40242	U16	Grid High Voltage Recover Threshold (% of Reg 40239)	0.1 %	n/a	1060	1000	1200	RWO
40243	U16	Grid Low Voltage Trip Threshold (% of Reg 40239)	0.1 %	n/a	700	500	1000	RWO
40244	U16	Grid Low Voltage Recover Threshold (% of Reg 40239)	0.1 %	n/a	880	500	1000	RWO
40245	U16	Grid High Frequency Trip Threshold (Delta above Reg 40240)	0.01 Hz	n/a	200	0	2000	RWO
40246	U16	Grid High Frequency Recover Threshold (Delta above Reg 40240)	0.01 Hz	n/a	100	0	2000	RWO
40247	U16	Grid Low Frequency Trip Threshold (Delta below Reg 40240)	0.01 Hz	n/a	200	0	2000	RWO
40248	U16	Grid Low Frequency Recover Threshold (Delta below Reg 40240)	0.01 Hz	n/a	100	0	2000	RWO
40249	U16	Resume from offline Delay	0.1 sec	n/a	10	0	36000	RW
40250	U16	Resume from Offline Max Retries	n/a	n/a	2	0	100	RW
40251	U16	Resume from Offline Retry Window	0.1 sec	n/a	50	0	36000	RW
40252	U16	Offline Timeout	1 sec	n/a	0	0	64800	RW

11.2.8 Oztek Extension Model 64054 Registers – Firmware Update

Number	Data Type	Description	Units	Scale Factor (Reg #)	Factory Default	Min	Max	Access Level
Header:								
40261	U16	Model Identifier	n/a	n/a	64054	n/a	n/a	R
40262	U16	Model Length - # of 16-bit registers to follow	n/a	n/a	148	n/a	n/a	R
Fixed Block:								
40263	U16	Firmware Update – Jump to Bootloader Command	n/a	n/a	0	0	1	RWO

Number	Data Type	Description	Units	Scale Factor (Reg #)	Factory Default	Min	Max	Access Level
40264	U16	Firmware Update – Data Transmission Object, Word 0 (DTO_WRD0) MSB = Return Code; LSB = Packet ID	n/a	n/a	0	n/a	n/a	R
40265	U16	Firmware Update – Data Transmission Object, Word 1 (DTO_WRD1) MSB = Data Byte 0; LSB = Count	n/a	n/a	0	n/a	n/a	R
40266	U16	Firmware Update – Data Transmission Object, Word 2 (DTO_WRD2) MSB = Data Byte 2; LSB = Data Byte 1	n/a	n/a	0	n/a	n/a	R
40267	U16	Firmware Update – Data Transmission Object, Word 3 (DTO_WRD3) MSB = Data Byte 4; LSB = Data Byte 3	n/a	n/a	0	n/a	n/a	R
40268	U16	Firmware Update – Control Receive Object, Word 0 (CRO_WRD0) MSB = Count; LSB = Command	n/a	n/a	0	0	65535	RWC
40269	U16	Firmware Update – Control Receive Object, Word 1 (CRO_WRD1) MSB = Data Byte 1; LSB = Data Byte 0	n/a	n/a	0	0	65535	RWC
40270	U16	Firmware Update – Control Receive Object, Word 2 (CRO_WRD2) MSB = Data Byte 3; LSB = Data Byte 2	n/a	n/a	0	0	65535	RWC
40271 - 40393	U16	CRO_WRD3 ... CRO_WRD125	n/a	n/a	0	0	65535	RWC
40394	U16	Firmware Update – Control Receive Object, Word 126 (CRO_WRD126) MSB = Data Byte 252; LSB = Data Byte 251	n/a	n/a	0	0	65535	RWC

11.2.9 Oztek Extension Model 64055 Registers – Datalogging

Number	Data Type	Description	Units	Scale Factor (Reg #)	Factory Default	Min	Max	Access Level
Header:								
40411	U16	Model Identifier	n/a	n/a	64055	n/a	n/a	R
40412	U16	Model Length - # of 16-bit registers to follow	n/a	n/a	126	n/a	n/a	R
Fixed Block:								

Number	Data Type	Description	Units	Scale Factor (Reg #)	Factory Default	Min	Max	Access Level
40413	U32	<p>Real Time Clock – Set Date</p> <p>This register is used to set the date using the following format:</p> <p>BITS [13..0] = Year BITS [15..14] = not used BITS [23..16] = Month BITS [31..21] = Day</p> <p>Example: 3/21/2017 would be 0x150307E1</p> <p>NOTE: <i>For synchronization purposes, the Date is internally latched upon writing the Set Time Register, 40415. If the user fails to write to register 40415, the date will NOT be set. To correctly set the date and time, the user should write to register 40413, followed by a write to 40415.</i></p>	ENUM	n/a	0	0	0x1F0C FFFF	RWC
40415	U32	<p>Real Time Clock – Set Time</p> <p>This register is used to set the time using the following format:</p> <p>BITS [7..0] = Hours BITS [15..8] = Minutes BITS [23..16] = Seconds BITS [31..24] = not used</p> <p>Example: 1:48pm would be 0x0000300D</p> <p>NOTE: <i>For synchronization purposes, writing to this register also latches the data written to register 40413. To correctly set the date and time, the user should write to register 40413, followed by a write to 40415.</i></p>	ENUM	n/a	0	0	0x003B 3B17	RWC
40417	U32	<p>Real Time Clock – Get Date</p> <p>Returns the Date in the following format:</p> <p>BITS [13..0] = Year BITS [14] = Set Status: 0 = Date has not been set since POR 1 = Date has been set since POR</p> <p>BITS [15] = not used BITS [23..16] = Month BITS [31..21] = Day</p>	ENUM	n/a	n/a	n/a	n/a	R

Number	Data Type	Description	Units	Scale Factor (Reg #)	Factory Default	Min	Max	Access Level
40419	U32	<p>Real Time Clock – Get Time Returns the Time in the following format: BITS [7..0] = Hours BITS [15..8] = Minutes BITS [23..16] = Seconds BITS [30..24] = not used BITS [31] = Set Status: 0 = Time has not been set since POR 1 = Time has been set since POR</p> <p>NOTE: For synchronization purposes, the Time data is internally latched when register 40417 is read. To correctly read the time, the user must first read register 40417, followed by a read to 40419.</p>	ENUM	n/a	n/a	n/a	n/a	R
40421	U16	Fault Log – Sample Period	ms	n/a	1	n/a	n/a	R
40422	U16	Fault Log – Number of Available Logs Returns the number of logs containing valid data.	n/a	n/a	n/a	0	12	R
40423	U16	Reserved Factory Command Register	ENUM	n/a	n/a	n/a	n/a	R
40424	U16	Reserved Factory Status Register	ENUM	n/a	n/a	n/a	n/a	R
40425	U16	Fault Log – Select Log Used to select a log from which to read header and/or data from.	n/a	n/a	0	0	11	RWC
40426	U16	Fault Log – Get Header Get the header for the log selected by register 40425 . Header data will be placed in Data Log Read Buffer 40460-40523 . See section 9.1.19.1.2.5 for details on the header information. 0 = NOP 1 = Fetch Data	ENUM	n/a	0	0	1	RWC
40427	U16	Fault Log – Get Selected Record Writing the desired sample record # to this register will load that data from the log specified by register 40425 into the Data Log Read Buffer 40460-40523 .	n/a	n/a	0	0	0xFFFF	RWC
40428	U16	Reserved Factory Command Register	ENUM	n/a	n/a	n/a	n/a	R

Number	Data Type	Description	Units	Scale Factor (Reg #)	Factory Default	Min	Max	Access Level
40429	U16	User Log – Start/Stop Used to start the data logger and arm the trigger. 0 = Stop 1 = Start	ENUM	n/a	0	0	1	RWC
40430	U16	User Log – Post Trigger Percentage Defines how much of the buffer is used for storing post trigger data.	%	n/a	0	0	100	RWC
40431	U16	User Log – Sample Period Sets the time between samples for the User Log. See section 9.1.2.2 for details on selecting the sample period.	ms	n/a	10	10	1000	RWC
40432	U32	User Log – Variable Selection (LSW) See section 9.1.2.1 for details.	n/a	n/a	1	0	0xFFFF FFFF	RWC
40434	U32	User Log – Variable Selection (MSW) See section 9.1.2.1 for details.	n/a	n/a	0	0	0xFFFF FFFF	RWC
40436	U16	User Log – Trigger Mode See section 9.1.2.3 for details. 0 = Continuous 1 = Single 2 = Dual OR 3 = Dual AND	ENUM	n/a	0	0	3	RWC
40437	U16	User Log – Trigger 1 Compare Type See section 9.1.2.4 for details. 0 = Less Than 1 = Greater Than 2 = Equal To 3 = Not Equal To	ENUM	n/a	0	0	3	RWC
40438	U16	User Log – Trigger 1 Variable Selection See section 9.1.2.4 for details.	n/a	n/a	0	0	63	RWC
40439	U32	User Log – Trigger 1 Value Mask See section 9.1.2.4 for details.	n/a	n/a	0	0	0xFFFF FFFF	RWC
40441	U32	User Log – Trigger 1 Value See section 9.1.2.4 for details.	n/a	n/a	0	0	0xFFFF FFFF	RWC

Number	Data Type	Description	Units	Scale Factor (Reg #)	Factory Default	Min	Max	Access Level
40443	U16	User Log – Trigger 2 Compare Type See section 9.1.2.4 for details. 0 = Less Than 1 = Greater Than 2 = Equal To 3 = Not Equal To	ENUM	n/a	0	0	3	RWC
40444	U16	User Log – Trigger 2 Variable Selection See section 9.1.2.4 for details.	n/a	n/a	0	0	63	RWC
40445	U32	User Log – Trigger 2 Value Mask See section 9.1.2.4 for details.	n/a	n/a	0	0	0xFFFF FFFF	RWC
40447	U32	User Log – Trigger 2 Value See section 9.1.2.4 for details.	n/a	n/a	0	0	0xFFFF FFFF	RWC
40449	U16	User Log – Status 0 = Idle 1 = Capturing (no Trigger) 2 = Capturing (Triggered) 3 = Finished	ENUM	n/a	n/a	n/a	n/a	R
40450	U16	User Log – Get Header Get the header for the User Log. Header data will be placed in Data Log Read Buffer 40460-40523 . See section 9.1.2.5 for details on the header information. 0 = NOP 1 = Fetch Data	ENUM	n/a	0	0	1	RWC
40451	U16	User Log – Get Selected Sample Data Writing the desired sample record # to this register will load that data from the User log into the Data Log Read Buffer 40460-40523 .	n/a	n/a	0	0	0xFFFF	RWC
40452	U16	Fault History Log – Set Fault Index Write the bit # of the corresponding fault bit in register 40129 Fault Status for which to read the fault history.	n/a	n/a	0	0	63	RWC
40453	U16	Fault History Log – # of Entries for Specified Fault Returns the # of entries that have been stored for the fault specified by register 40452 .	n/a	n/a	n/a	n/a	n/a	R

Number	Data Type	Description	Units	Scale Factor (Reg #)	Factory Default	Min	Max	Access Level
40454	U16	Fault History Log – Get History Data for Specified Fault Writing a “1” will load the history data for the fault specified by register 40452 into the Data Log Read Buffer 40460-40523 . 0 = NOP 1 = Fetch Data	ENUM	n/a	0	0	1	RWC
40455	U16	Reserved Factory Command Register	ENUM	n/a	n/a	n/a	n/a	R
40456	U16	Operation Log – Read Timer Variables See section 9.3.1 for additional details. MSB = # of variables to be read; LSB = Variable Index	ENUM	n/a	0	0	0xFFFF	RWC
40457	U16	Operation Log – Read Fault Counts See section 9.2.1 for additional details. MSB = # of variables to be read; LSB = Variable Index	ENUM	n/a	0	0	0xFFFF	RWC
40458	U16	Operation Log – Read Min/Max Values See section 9.3.2 for additional details. MSB = # of variables to be read; LSB = Variable Index	ENUM	n/a	0	0	0xFFFF	RWC
40459	U16	Reserved Factory Command	ENUM	n/a	n/a	n/a	n/a	R
40460 - 40523	U32	Datalog – Read Buffer	n/a	n/a	n/a	n/a	n/a	R

11.2.10 SunSpec Model 0xFFFF Registers – End Model

Number	Data Type	Description	Units	Scale Factor (Reg #)	Factory Default	Min	Max	Access Level
<i>Header:</i>								
40539	U16	Model Identifier	n/a	n/a	0xFFFF	n/a	n/a	R
40540	U16	Model Length - # of 16-bit registers to follow	n/a	n/a	0	n/a	n/a	R

12. Servicing the Unit

The supply is not field serviceable. If the unit needs to return to the manufacturer for evaluation and possible repair, consult the Return Material Authorization Policy of this document as to how to proceed. In removing the supply from system installation, consult and follow the Electrical Safety precautions of Section 1.3.

13. Maintenance and Upgrade

Electrical connections should be regularly checked for mechanical integrity and thermal degradation. Airflow must be maintained unobstructed for maximum performance.

13.1 Firmware Updates



CAUTION

When performing firmware updates, the software may automatically reset the values of the configuration registers back to their factory default values. The user must take care to save a copy of any custom settings prior to performing the firmware update.

It is important that the PCS remain powered for up to 5 sec following a firmware upgrade. This allows time for the application firmware to complete the configuration update. Removing bias power before the update is complete can corrupt the non-volatile, configuration memory.

The supply supports in-system firmware updates. The Oztek provided Power Studio™ Tool can be used to perform the update, or alternatively, the customer can incorporate the update functionality into their system controller. The firmware update register set is defined in Section 11.2.8 Oztek Extension Model 64054 Registers – Firmware Update.

To begin the update process, the system controller must first write a 1 to **REG 40263 – Jump to Bootloader Command**. This causes the power supply to load and execute the bootloader image, after which it will only respond to read/writes of registers 40264 through 40394. Once the update is complete, the bootloader provides a command to resume execution of the power supply application. Please consult FS-0057 – TMS28x CAN Bootloader Functional Specification for details on how to use these registers to update the application image.

The four LED status indicators on the front panel are used to provide Bootloader status and progress information. Table 6 defines each LEDs meaning when the bootloader is running.

**CAUTION**

The Modbus Addresses provided in the Modbus Register Map table in FS-0057 should be replaced with the corresponding register addresses, 40264 through 40394, in section 11.2.8 Oztek Extension Model 64054 Registers – Firmware Update.

14. Oztek Power Studio™ Tool

The Oztek Power Studio™ tool is a Microsoft Windows based Graphical User Interface (GUI), as shown in Figure 23, which can be used to easily configure and control the power supply. The tool communicates with the unit using Modbus and provides a simple, intuitive user interface. Some of the features provided by Power Studio™ include:

- Simple tabbed interfaces:
 - Dashboard
 - Configuration
 - Instrumentation
 - Software Upgrade
 - Datalogging
- Dashboard for power supply control and monitoring
- Multi-Target Support
- Power supply configuration control, including:
 - Editing configurations
 - Downloading/uploading configurations
 - Archiving multiple configuration files

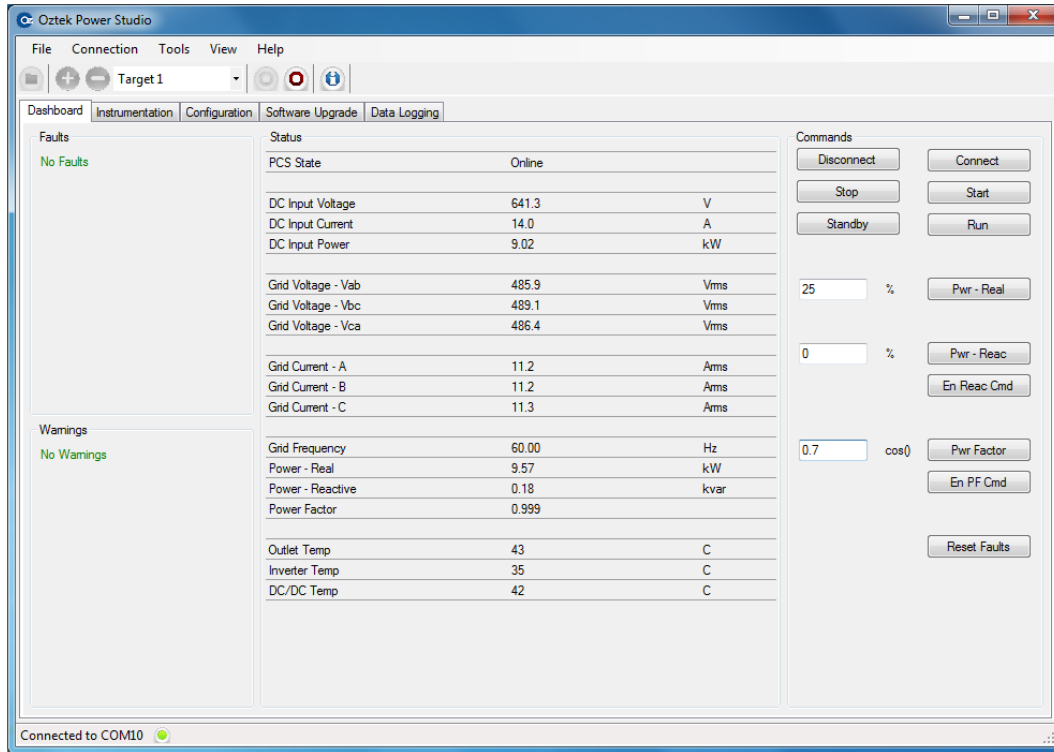

Figure 23 - Oztek Power Studio™ GUI

For detailed information and operating instructions, please refer to UM-0052 Oztek Power Studio™ User's Manual.

15. Appendix A – Records of Certification



AUTHORIZATION TO MARK

This authorizes the application of the Certification Mark(s) shown below to the models described in the Product(s) Covered section when made in accordance with the conditions set forth in the Certification Agreement and Listing Report. This authorization also applies to multiple listee model(s) identified on the correlation page of the Listing Report.

This document is the property of Intertek Testing Services and is not transferable. The certification mark(s) may be applied only at the location of the Party Authorized To Apply Mark.

Applicant: Trystar, LLC	Manufacturer: Trystar, LLC
Address: 11 Continental Blvd Merrimack, NH 03054	Address: 11 Continental Blvd Merrimack, NH 03054
Country: USA	Country: USA
Party Authorized To Apply Mark: Same as Manufacturer	
Report Issuing Office: Intertek Testing Services NA, Inc., Cortland, NY	
Control Number: <u>5014987</u>	Authorized by: <u><i>L. Matthew Snyder</i></u> for L. Matthew Snyder, Certification Manager



This document supersedes all previous Authorizations to Mark for the noted Report Number.

This Authorization to Mark is for the exclusive use of Intertek's Client and is provided pursuant to the Certification agreement between Intertek and its Client. Intertek's responsibility and liability are limited to the terms and conditions of the agreement. Intertek assumes no liability to any party, other than to the Client in accordance with the agreement, for any loss, expense or damage occasioned by the use of this Authorization to Mark. Only the Client is authorized to permit copying or distribution of this Authorization to Mark and then only in its entirety. Use of Intertek's Certification mark is restricted to the conditions laid out in the agreement and in this Authorization to Mark. Any further use of the Intertek name for the sale or advertisement of the tested material, product or service must first be approved in writing by Intertek. Initial Factory Assessments and Follow up Services are for the purpose of assuring appropriate usage of the Certification mark in accordance with the agreement, they are not for the purposes of production quality control and do not relieve the Client of their obligations in this respect.

Intertek Testing Services NA Inc.
545 East Algonquin Road, Arlington Heights, IL 60005
Telephone 800-345-3851 or 847-439-5667 Fax 312-283-1672

Standard(s):	Inverters, Converters, Controllers and Interconnection System Equipment for use with Distributed Energy Resources - Including Supplement SA [UL 1741:2021 Ed.3 (Including Supplement SA)] Power Conversion Equipment [CSA C22.2#107.1:2016 Ed.4]
Product:	Energy Storage Power Conversion System
Models:	OZPCS-RS40 may be followed by -PS; followed by -F or -B; followed by two numbers.



Warranty and Product Information

Limited Warranty

What does this warranty cover and how long does it last? This Limited Warranty is provided by Oztek Corp. ("Oztek") and covers defects in workmanship and materials in your power supply. This Warranty Period lasts for 5 years from the date of purchase at the point of sale to you, the original end user customer, unless otherwise agreed in writing. You will be required to demonstrate proof of purchase to make warranty claims. This Limited Warranty is transferable to subsequent owners but only for the unexpired portion of the Warranty Period. Subsequent owners also require original proof of purchase as described in "What proof of purchase is required?" An extended warranty is available for purchase; contact Oztek Sales for details.

What will Oztek do? During the Warranty Period Oztek will, at its option, repair the product (if economically feasible) or replace the defective product free of charge, provided you notify Oztek of the product defect within the Warranty Period, and provided that through inspection Oztek establishes the existence of such a defect and that it is covered by this Limited Warranty.

Oztek will, at its option, use new and/or reconditioned parts in performing warranty repair and building replacement products. Oztek reserves the right to use parts or products of original or improved design in the repair or replacement. If Oztek repairs or replaces a product, its warranty continues for the remaining portion of the original Warranty Period or 90 days from the date of the return shipment to the customer, whichever is greater. All replaced products and all parts removed from repaired products become the property of Oztek.

Oztek covers both parts and labor necessary to repair the product and return shipment to the customer via an Oztek-selected non-expedited surface freight within the contiguous United States and Canada. Alaska, Hawaii and locations outside of the United States and Canada are excluded. Contact Oztek Customer Service for details on freight policy for return shipments from excluded areas.

How do you get service? If your product requires troubleshooting or warranty service, contact your merchant. If you are unable to contact your merchant, or the merchant is unable to provide service, contact Oztek directly at:

USA
Telephone: 603-546-0090
Email techsupport@oztekc corp.com

Direct returns may be performed according to the Oztek Return Material Authorization Policy described in your product manual.

What proof of purchase is required? In any warranty claim, dated proof of purchase must accompany the product and the product must not have been disassembled or modified without prior written authorization by Oztek. Proof of purchase may be in any one of the following forms:

- The dated purchase receipt from the original purchase of the product at point of sale to the end user
- The dated dealer invoice or purchase receipt showing original equipment manufacturer (OEM) status
- The dated invoice or purchase receipt showing the product exchanged under warranty

What does this warranty not cover? Claims are limited to repair and replacement, or if in Oztek's discretion that is not possible, reimbursement up to the purchase price paid for the product. Oztek will be liable to you only for direct damages suffered by you and only up to a maximum amount equal to the purchase price of the product. This Limited Warranty does not warrant uninterrupted or error-free operation of the product or cover normal wear and tear of the product or costs related to the removal, installation, or troubleshooting of the customer's electrical systems. This warranty does not apply to and Oztek will not be responsible for any defect in or damage to:

- a) The product if it has been misused, neglected, improperly installed, physically damaged or altered, either internally or externally, or damaged from improper use or use in an unsuitable environment
- b) The product if it has been subjected to fire, water, generalized corrosion, biological infestations, or input voltage that creates operating conditions beyond the maximum or minimum limits listed in the Oztek product specifications including high input voltage from generators and lightning strikes
- c) The product if repairs have been done to it other than by Oztek or its authorized service centers (hereafter "ASCs")
- d) The product if it is used as a component part of a product expressly warranted by another manufacturer
- e) The product if its original identification (trade-mark, serial number) markings have been defaced, altered, or removed
- f) The product if it is located outside of the country where it was purchased
- g) Any consequential losses that are attributable to the product losing power whether by product malfunction, installation error or misuse.

Disclaimer

Product

THIS LIMITED WARRANTY IS THE SOLE AND EXCLUSIVE WARRANTY PROVIDED BY OZTEK IN CONNECTION WITH YOUR OZTEK PRODUCT AND IS, WHERE PERMITTED BY LAW, IN LIEU OF ALL OTHER WARRANTIES, CONDITIONS, GUARANTEES, REPRESENTATIONS, OBLIGATIONS AND LIABILITIES, EXPRESS OR IMPLIED, STATUTORY OR OTHERWISE IN CONNECTION WITH THE PRODUCT, HOWEVER ARISING (WHETHER BY CONTRACT, TORT, NEGLIGENCE, PRINCIPLES OF MANUFACTURER'S LIABILITY, OPERATION OF LAW, CONDUCT, STATEMENT OR OTHERWISE), INCLUDING WITHOUT RESTRICTION ANY IMPLIED WARRANTY OR CONDITION OF QUALITY, MERCHANTABILITY OR FITNESS FOR A PARTICULAR PURPOSE. ANY IMPLIED WARRANTY OF MERCHANTABILITY OR FITNESS FOR A PARTICULAR PURPOSE TO THE EXTENT REQUIRED UNDER APPLICABLE LAW TO APPLY TO THE PRODUCT SHALL BE LIMITED IN DURATION TO THE PERIOD STIPULATED UNDER THIS LIMITED WARRANTY. IN NO EVENT WILL OZTEK BE LIABLE FOR: (a) ANY SPECIAL, INDIRECT, INCIDENTAL OR CONSEQUENTIAL DAMAGES, INCLUDING LOST PROFITS, LOST REVENUES, FAILURE TO REALIZE EXPECTED SAVINGS, OR OTHER COMMERCIAL OR ECONOMIC LOSSES OF ANY KIND, EVEN IF OZTEK HAS BEEN ADVISED, OR HAD REASON TO KNOW, OF THE POSSIBILITY OF SUCH DAMAGE, (b) ANY LIABILITY ARISING IN TORT, WHETHER OR NOT ARISING OUT OF OZTEK'S NEGLIGENCE, AND ALL LOSSES OR DAMAGES TO ANY PROPERTY OR FOR ANY PERSONAL INJURY OR ECONOMIC LOSS OR DAMAGE CAUSED BY THE CONNECTION OF A PRODUCT TO ANY OTHER DEVICE OR SYSTEM, AND (c) ANY DAMAGE OR INJURY ARISING FROM OR AS A RESULT OF MISUSE OR ABUSE, OR THE INCORRECT INSTALLATION, INTEGRATION OR OPERATION OF THE PRODUCT. IF YOU ARE A CONSUMER (RATHER THAN A PURCHASER OF THE PRODUCT IN THE COURSE OF A BUSINESS) AND PURCHASED THE PRODUCT IN A MEMBER STATE OF THE EUROPEAN UNION, THIS LIMITED WARRANTY SHALL BE SUBJECT TO YOUR STATUTORY RIGHTS AS A CONSUMER UNDER THE EUROPEAN UNION PRODUCT WARRANTY DIRECTIVE 1999/44/EC AND AS SUCH DIRECTIVE HAS BEEN IMPLEMENTED IN THE EUROPEAN UNION MEMBER STATE WHERE YOU PURCHASED THE PRODUCT. FURTHER, WHILE THIS LIMITED WARRANTY GIVES YOU SPECIFIC LEGAL RIGHTS, YOU MAY HAVE OTHER RIGHTS WHICH MAY VARY FROM EU MEMBER STATE TO EU MEMBER STATE OR, IF YOU DID NOT PURCHASE THE PRODUCT IN AN EU MEMBER STATE, IN THE COUNTRY YOU PURCHASED THE PRODUCT WHICH MAY VARY FROM COUNTRY TO COUNTRY AND JURISDICTION TO JURISDICTION.

Return Material Authorization Policy

Before returning a product directly to Oztek you must obtain a Return Material Authorization (RMA) number and the correct factory "Ship To" address. Products must also be shipped prepaid. Product shipments will be refused and returned at your expense if they are unauthorized, returned without an RMA number clearly marked on the outside of the shipping box, if they are shipped collect, or if they are shipped to the wrong location.

When you contact Oztek to obtain service, please have your instruction manual ready for reference and be prepared to supply:

- The serial number of your product
- Information about the installation and use of the unit
- Information about the failure and/or reason for the return
- A copy of your dated proof of purchase

Return Procedure

Package the unit safely, preferably using the original box and packing materials. Please ensure that your product is shipped fully insured in the original packaging or equivalent. This warranty will not apply where the product is damaged due to improper packaging. Include the following:

- The RMA number supplied by Oztek clearly marked on the outside of the box.
- A return address where the unit can be shipped. Post office boxes are not acceptable.
- A contact telephone number where you can be reached during work hours.
- A brief description of the problem.

Ship the unit prepaid to the address provided by your Oztek customer service representative.

If you are returning a product from outside of the USA or Canada - In addition to the above, you **MUST** include return freight funds and you are fully responsible for all documents, duties, tariffs, and deposits.

Out of Warranty Service

If the warranty period for your product has expired, if the unit was damaged by misuse or incorrect installation, if other conditions of the warranty have not been met, or if no dated proof of purchase is available, your unit may be serviced or replaced for a flat fee. If a unit cannot be serviced due to damage beyond salvation or because the repair is not economically feasible, a labor fee may still be incurred for the time spent making this determination.

To return your product for out of warranty service, contact Oztek Customer Service for a Return Material Authorization (RMA) number and follow the other steps outlined in "Return Procedure".

Payment options such as credit card or money order will be explained by the Customer Service Representative. In cases where the minimum flat fee does not apply, as with incomplete units or units with excessive damage, an additional fee will be charged. If applicable, you will be contacted by Customer Service once your unit has been received.

Optional Extended Warranty

Limited Extended Warranty

What does this warranty cover and how long does it last? This Limited Extended Warranty is provided by Oztek Corp. ("Oztek") and covers defects in workmanship and materials in your PCS. This Warranty extends the duration of warranty protection period to 10 years from the date of purchase at the point of sale to you, the original end user customer, unless otherwise agreed in writing. This Extended Warranty does not increase the duration of coverage for the cooling fans, which are considered a wear item. You will be required to demonstrate proof of purchase to make warranty claims. This Limited Warranty is transferable to subsequent owners but only for the unexpired portion of the Warranty Period. Subsequent owners also require original proof of purchase as described in "What proof of purchase is required?"

What will Oztek do? During the Warranty Period Oztek will, at its option, repair the product (if economically feasible) or replace the defective product free of charge, provided you notify Oztek of the product defect within the Warranty Period, and provided that through inspection Oztek establishes the existence of such a defect and that it is covered by this Limited Warranty.

Oztek will, at its option, use new and/or reconditioned parts in performing warranty repair and building replacement products. Oztek reserves the right to use parts or products of original or improved design in the repair or replacement. If Oztek repairs or replaces a product, its warranty continues for the remaining portion of the original Warranty Period or 90 days from the date of the return shipment to the customer, whichever is greater. All replaced products and all parts removed from repaired products become the property of Oztek.

Oztek covers both parts and labor necessary to repair the product and return shipment to the customer via an Oztek-selected non-expedited surface freight within the contiguous United States and Canada. Alaska, Hawaii and locations outside of the United States and Canada are excluded. Contact Oztek Customer Service for details on freight policy for return shipments from excluded areas.

How do you get service? If your product requires troubleshooting or warranty service, contact your merchant. If you are unable to contact your merchant, or the merchant is unable to provide service, contact Oztek directly at:

USA
Telephone: 603-546-0090
Email techsupport@oztekc corp.com

Direct returns may be performed according to the Oztek Return Material Authorization Policy described in your product manual.

What proof of purchase is required? In any warranty claim, dated proof of purchase must accompany the product unless you have received written Return Material Authorization from Oztek stating that further proof of purchase is not required. Proof of purchase may be in any one of the following forms:

- The dated purchase receipt from the original purchase of the product at point of sale to the end user
- The dated dealer invoice or purchase receipt showing original equipment manufacturer (OEM) status
- The dated invoice or purchase receipt showing the product exchanged under warranty

What does this warranty not cover? Claims are limited to repair and replacement, or if in Oztek's discretion that is not possible, reimbursement up to the purchase price paid for the product. Oztek will be liable to you only for direct damages suffered by you and only up to a maximum amount equal to the purchase price of the product. This Limited Warranty does not warrant uninterrupted or error-free operation of the product or cover normal wear and tear of the product or costs related to the removal, installation, or troubleshooting of the customer's electrical systems. This warranty does not apply to and Oztek will not be responsible for any defect in or damage to:

- a) The product if it has been misused, neglected, improperly installed, physically damaged or altered, either internally or externally, or damaged from improper use or use in an unsuitable environment, or operated outside of the safe operating zones specified in the OZpcs-RS40-PS User's Manual.
- b) The product if it has been subjected to fire, water, generalized corrosion, biological infestations, or input voltage that creates operating conditions beyond the maximum or minimum limits listed in the Oztek product specifications including high input voltage from generators and lightning strikes
- c) The product if repairs have been done to it other than by Oztek or its authorized service centers (hereafter "ASCs")
- d) The product if it is used as a component part of a product expressly warranted by another manufacturer
- e) The product if its original identification (trademark, serial number) markings have been defaced, altered, or removed
- f) Any consequential losses that are attributable to the product losing power whether by product malfunction, installation error or misuse.

Disclaimer

Product

THIS LIMITED WARRANTY IS THE SOLE AND EXCLUSIVE WARRANTY PROVIDED BY OZTEK IN CONNECTION WITH YOUR OZTEK PRODUCT AND IS, WHERE PERMITTED BY LAW, IN LIEU OF ALL OTHER WARRANTIES, CONDITIONS, GUARANTEES, REPRESENTATIONS, OBLIGATIONS AND LIABILITIES, EXPRESS OR IMPLIED, STATUTORY OR OTHERWISE IN CONNECTION WITH THE PRODUCT, HOWEVER ARISING (WHETHER BY CONTRACT, TORT, NEGLIGENCE, PRINCIPLES OF MANUFACTURER'S LIABILITY, OPERATION OF LAW, CONDUCT, STATEMENT OR OTHERWISE), INCLUDING WITHOUT RESTRICTION ANY IMPLIED WARRANTY OR CONDITION OF QUALITY, MERCHANTABILITY OR FITNESS FOR A PARTICULAR PURPOSE. ANY IMPLIED WARRANTY OF MERCHANTABILITY OR FITNESS FOR A PARTICULAR PURPOSE TO THE EXTENT REQUIRED UNDER APPLICABLE LAW TO APPLY TO THE PRODUCT SHALL BE LIMITED IN DURATION TO THE PERIOD STIPULATED UNDER THIS LIMITED WARRANTY. IN NO EVENT WILL OZTEK BE LIABLE FOR: (a) ANY SPECIAL, INDIRECT, INCIDENTAL OR CONSEQUENTIAL DAMAGES, INCLUDING LOST PROFITS, LOST REVENUES, FAILURE TO REALIZE EXPECTED SAVINGS, OR OTHER COMMERCIAL OR ECONOMIC LOSSES OF ANY KIND, EVEN IF OZTEK HAS BEEN ADVISED, OR HAD REASON TO KNOW, OF THE POSSIBILITY OF SUCH DAMAGE, (b) ANY LIABILITY ARISING IN TORT, WHETHER OR NOT ARISING OUT OF OZTEK'S NEGLIGENCE, AND ALL LOSSES OR DAMAGES TO ANY PROPERTY OR FOR ANY PERSONAL INJURY OR ECONOMIC LOSS OR DAMAGE CAUSED BY THE CONNECTION OF A PRODUCT TO ANY OTHER DEVICE OR SYSTEM, AND (c) ANY DAMAGE OR INJURY ARISING FROM OR AS A RESULT OF MISUSE OR ABUSE, OR THE INCORRECT INSTALLATION, INTEGRATION OR OPERATION OF THE PRODUCT. IF YOU ARE A CONSUMER (RATHER THAN A PURCHASER OF THE PRODUCT IN THE COURSE OF A BUSINESS) AND PURCHASED THE PRODUCT IN A MEMBER STATE OF THE EUROPEAN UNION, THIS LIMITED WARRANTY SHALL BE SUBJECT TO YOUR STATUTORY RIGHTS AS A CONSUMER UNDER THE EUROPEAN UNION PRODUCT WARRANTY DIRECTIVE 1999/44/EC AND AS SUCH DIRECTIVE HAS BEEN IMPLEMENTED IN THE EUROPEAN UNION MEMBER STATE WHERE YOU PURCHASED THE PRODUCT. FURTHER, WHILE THIS LIMITED WARRANTY GIVES YOU SPECIFIC LEGAL RIGHTS, YOU MAY HAVE OTHER RIGHTS WHICH MAY VARY FROM EU MEMBER STATE TO EU MEMBER STATE OR, IF YOU DID NOT PURCHASE THE PRODUCT IN AN EU MEMBER STATE, IN THE COUNTRY YOU PURCHASED THE PRODUCT WHICH MAY VARY FROM COUNTRY TO COUNTRY AND JURISDICTION TO JURISDICTION.